



DELHI UNIVERSITY
LIBRARY

ESSENTIALS OF STAGE-PLANNING

ESSENTIALS
OF
STAGE-PLANNING

BY

STANLEY BELL · NORMAN MARSHALL
& RICHARD SOUTHERN

WITH ILLUSTRATIONS BY

RICHARD LEACROFT, A.R.I.B.A.

AND A FOREWORD BY

GEOFFREY WHITWORTH

Under the auspices of the British Drama League

LONDON
FREDERICK MULLER LTD
29 Great James Street
W.C.1

FIRST PUBLISHED BY FREDERICK MULLER LTD.

IN 1949

PRINTED IN GREAT BRITAIN BY

THE CAMELOT PRESS LTD.

LONDON AND SOUTHAMPTON



CONTENTS

GENERAL PRELIMINARIES

FOREWORD	page ix
1. GENERAL PRELIMINARIES	i
2. SMALL AND MULTI-PURPOSE HALLS	8
(a) Adapting Existing Space	8
(b) Initiating a New Community Theatre	18

THE STAGE IN DETAIL

3. THE STAGE FLOOR	24
(a) Stage-level	24
(b) Stage-rake	26
(c) Stage Shape	26
(d) Material of the Stage Floor	28
(e) Structure of the Stage Floor	29
(f) Trapdoors on the Stage Floor	29
(g) Divisions of the Stage: (1) The Acting-area	32
(h) Divisions of the Stage: (2) The Wing-spaces	33
(i) Divisions of the Stage: (3) The Up-stage Space	36
(j) Divisions of the Stage: (4) The Forestage	36
(k) Concerning Revolves	42
4. THE 'ROOF' OVER THE STAGE	45
(a) On Hanging and Flying Scenery	45
(b) The Grid and its Lines	46
(c) The Height of the Grid	47
(d) A Grid Substitute for Small Stages	48
(e) The Counterweight System	53
5. THE STAGE BACK-WALL	59
(a) The Need for a Passage Across	59
(b) The Nature of the Cyclorama	60
(c) The Limited Application of the Cyclorama System to Certain Small Stages	66

ESSENTIALS OF STAGE-PLANNING

6. THE FRONT WALL OF THE STAGE	<i>page</i> 70
(a) The Actors' Contact with the Audience	70
(b) The Function of the Front Wall	71
(c) The Proscenium and the Stage-mask	72
(d) Concerning the Abolition of the Proscenium	73
(e) Advantages and Limitations of the Varieties of Proscenium	75
(f) The Size of the Proscenium Opening	79
(g) Functions of the Back of the Proscenium Wall	81
7. THE LEFT- AND RIGHT-HAND WALLS OF THE STAGE	83
(a) Entrances	83
(b) The Scene Door	84
(c) The Fly-floors	85
8. ANCILLARY STAGE OFFICES	87
The Shop, Scene-store, Paint-frame, Wardrobe and Dressing-rooms	

FINAL CONSIDERATIONS

9. SOME GENERAL CONSIDERATIONS ON THE FRONT-OF-HOUSE	89
(a) The Auditorium	89
(b) Front-of-house Offices: The Box-office, Vestibule and Foyer	93
(c) Stage Lighting	94
BIBLIOGRAPHY	101

ILLUSTRATIONS

FIG.

1. A Subject for Adaptation	<i>page</i> 6
2. A Stage in Ten Units	10
3. A Stage and Forestage in Ten Units	10
4. The Ensa Fit-up	11
5. A Fit-up on Ceiling Beams	12
6. Sight-lines and a Central Gangway	13
7. Sight-lines and Side Gangways	13
8. Staggered Seats	13
9. Disadvantage of a Flat Floor	14
10. Typical Adaptation of a Small Hall	16-17
11. A Stage without Flies	19
12. A Stage with Flies	19
13. A Scheme for a Dual-purpose Floor	21
14. Improved Adaptation of a Small Hall	<i>opp.</i> 22
15. A View of the Back of a Typical Scene	<i>opp.</i> 23
16. The Six Sides of the Cage	24
17. The Advantage of a Stage at Street Level	25
18. The Carpet Cut	31
19. The Divisions of the Stage	32
20. The Packs of Scenery	35
21. A Theatre unsuitable for Forestage Work	37
22. A Typical Little-theatre Forestage	38
23. 24. Substitute Forestages	39
25, 26. A Genuine Forestage	40
27. The Georgian Forestage	41
28. The Remains of the Forestage To-day	41
29, 30, 31, 32. The Problem of the Revolve	43
33. The Working of a Set of Lines	47
34, 35, 36, 37, 38. The Development of the Flying System	49-51
39. A 'Grid-Substitute' for Small Stages	52
40. The Single Purchase Counterweight System	56
41. The Double Purchase Counterweight System	57

ESSENTIALS OF STAGE-PLANNING

FIG.	page
42. The Full Cyclorama	62
43. The Curtailed Cyclorama	64
44. The Armed Batten Cloth	65
45a, 45b. A Curved and Plastered Back-wall on a Small Stage	67-68
46. A Simple Canvas Cyclorama	69
47, 48, 49. The Nature of the Proscenium	73
50. The Decorative Proscenium	76
51. The Proscenium as a Stage Mask	77
52. A Typical Curtain Proscenium	78
53. The 'Non-Existent' Proscenium	78
54. The Stage Manager's Desk	81
55. The Proscenium Bridge	86
56. A Typical Proscenium	
57. The Machinery Behind the Proscenium	
58. The Machinery on the Stage with the Proscenium Removed	} <i>inset</i>
59. Back View of the Machinery on the Stage	} <i>at p. 96</i>
60. Diagram of Lighting	97

Note. Figs. 15, 57, 58 and 59 offer a pictorial glossary of the technical terms used in this book.

FOREWORD

SINCE its foundation, the British Drama League has always felt a special concern for the problems of stage equipment and theatre architecture. Over a long period the League has published articles on various aspects of theatre design, and expert advisers have constantly been made available by the League to those who have asked for help in adapting existing premises or building new ones. The topic has attained a special urgency since the last world war. Not that many new buildings have lately been put in hand: that is forbidden by circumstance. But all over the country plans are being made for new theatres and school stages against the day when the present embargo on amenity building may be relaxed.

It is a matter for regret that those who have seen these new designs report that many of them are failing to achieve even a moderate standard of technical efficiency. Too often the treatment of a comparatively simple item like the back wall of a stage leaves much to be desired. Wing-space and the planning of the auditorium in relation to the stage are sometimes totally inadequate. Such errors arise not always from lack of funds, but from sheer ignorance of the basic principles which are common to the planning of all theatres, large or small. No one would think of designing a billiards-room whose proportions hindered the free manœuvre of the players round the table. The same degree of foresight is surely demanded of those responsible for the far more complicated requirements of a theatre.

Aware of the need for authoritative guidance in such matters, a Conference of the British Drama League held at Birmingham in 1946 urged the Council to sponsor a book which would do something to meet it. The Council in turn appointed a committee to undertake the work, its original members being Messrs. Leo Baker (Dramatic Adviser to the Carnegie United Kingdom Trust), Stanley Bell, Michael MacOwan, Norman Marshall, C. B. Purdom, and Richard Southern. This committee soon came to the conclusion that to deal separately with each of the various types of building to be covered by the book, ranging from the humblest Parish hall to the medium-sized theatre, would involve

FOREWORD

much repetition. So it was decided to deal primarily with the basic principles of stage architecture as exemplified in the large and medium-sized theatre, at the same time indicating such modifications as might be necessary in the case of smaller theatres and halls. This method may involve an unusual measure of collaboration on the part of the reader; but it appears to me that the method has been fully justified, and that here in small compass will be found a coherent and remarkably exhaustive handbook on a subject of almost limitless ramifications.

The committee mentioned above, after laying down the general line of procedure, agreed that the actual writing of the book should be entrusted to three of their number; that they should be given a free hand, and thus become responsible for the completed work. The writers have checked and counter-checked their individual views during the course of composition, and although it would be too much to expect that nothing in the book is controversial, I have seen no other which displays a more illuminating pooling of ideas.

Of the three authors, it may be observed that Stanley Bell has had a long and distinguished career as stage director. Beginning with Sir Herbert Tree, he has worked with most of the leading managements both in London and New York. During the last war he was responsible, on behalf of E.N.S.A., for designing and equipping over a hundred temporary theatres of every size and shape for the Army and the R.A.F. The name of Norman Marshall is widely known as a producer, not only in the West End theatre, but in what he has himself described as "The Other Theatre" in his recent book of that name. He began his career at the Festival Theatre, Cambridge; subsequently directed his own Gate Theatre (one of the most notable "other theatres" in the country), and latterly has worked at the Cambridge Arts Theatre and at Bristol in association with the Arts Council, and has produced many successes in London and New York. As an adjudicator and critic of amateur performances, he has given continued service to the British Drama League, and has thereby acquired an unrivalled insight into every phase of the amateur movement, and of the trying conditions which face the amateur company whether in town, village, school or factory. Mr. Richard Southern is our leading expert in technical theatre research. His published works include *Stage Setting*, *Proscenium and Sight-lines* and *The Georgian Playhouse*. These show in high degree his aptitude for historical study and its practical application to problems of theatre design. The authors I know would wish me also to mention the name of

FOREWORD

Mr. Denys Lasdun, the well-known architect, who gave them invaluable help at the outset of their labours.

To all those approaching the problem *de novo* this book should therefore have a special appeal. For in a short space is gathered a wealth of precept and example in every case the fruit of long and practical stage experience. To ignore this experience may easily result in a stage which will be a constant source of frustration, often involving further expenditure on reconstruction which may even then fail to put matters right.

It only remains to add that since the inception of this volume, its practical relevance has been greatly increased by the passage of the Local Government Act of 1948, whereby the theatre qualifies at last for the same kind of civic support that has long been available to art galleries, museums, municipal orchestras and libraries. Under Section 132 of this Act, powers are given to local authorities "to do or arrange for the doing of . . . anything necessary or expedient . . . for the provision of a theatre, concert hall, or other premises . . . for the giving of entertainments," provided that "the expenditure of a local authority . . . shall not in any year exceed the product of a rate of sixpence in the pound."

The terms of reference are wide—perhaps too wide—and it behoves local authorities everywhere to make sure that their powers are not squandered upon the trivial and the commonplace, but dedicated rather to the highest social and cultural interests of the community which they are there to serve. From this point of view the physical conditions of a playhouse are all-important. They set a standard for everything that happens within the theatre's walls. At this time of dramatic renaissance it is our hope that *Essentials of Stage-Planning* may do something to promote the proper design and equipment which are indeed essential if the theatres of the future are worthily to satisfy the legitimate demands of the artists and their public.

GEOFFREY WHITWORTH.



CHAPTER ONE

GENERAL PRELIMINARIES

THE principles of stage-planning that are discussed in this book are those of any typical contemporary stage. Special aspects of the main principles are many and the most important are touched on here, but above all it is the general principles—the essentials—which we wish to stress, whether the stage be large or small.

To-day, in the mid-twentieth century, the theatre is in a developmental phase. Our period is unlike the Georgian, when a regular and logical system of playhouse design had become current throughout England, but rather like the Restoration, when there was a new form to be fixed—something to accommodate the typical stage of the past and yet incorporate as well the new discoveries of the present.

There is a danger in forgetting that in the various special fields of the theatre to-day certain basic stage requirements stay the same. If we specialize without grasping the essentials we risk producing a group of theatres that are unsuitable for any but one sort of use. There are four types of theatre which may seem to have, and indeed *do* have, special requirements deserving detailed and separate study, but these we shall not attempt to discuss exhaustively. Instead, we claim that through all these types the basic essentials provide an indispensable framework common to all, and form the only sound starting-point for development.

The four special types of theatre are (1) the amateur hall, (2) the large capital theatre, (3) the theatre designed for experiment with new forms, and (4) the all-period theatre where it is intended to present the work of any age.

We have to face the contention that each of these is a separate subject. But we have found after very careful consideration over the material of this book that we cannot discover any differences between these four forms of stage *so far as concerns the basic essentials*.

Let us take the vexed question of that class of theatre which we name the

ESSENTIALS OF STAGE-PLANNING

amateur hall. Here, if anywhere, there is a demand for information. It has been one of the first objectives of this book to seek to answer that demand. But though a belief is current that amateur and professional theatres are fundamentally different and governed by different requirements, we have found ourselves unable to discover in practice any essential difference between them so far as planning is concerned. It is therefore our unanimous opinion that the *essential* requirements are identical in both kinds of theatre, and that where anything is lacking from an amateur stage, work upon it must be to that extent unsatisfactory.

It is important that here, as throughout this book, the word *essential* should be remembered. There is much in stage procedure which is to be classed outside the irreducible minimum for reasonably satisfactory work. But we have sought here to stress those matters without which it seems clear that reasonably satisfactory work is not possible.

Such matters—which form the material of this book—are unfortunately ill attended to in many theatres—professional as well as amateur—but wherever this is so, the consequence is the same—work cannot be satisfactory, or if by supreme exertion it be made so, it is only at the expense of unreasonable effort. The suggestion that the amateur should be more regardlessly subjected to that unreasonable effort than the professional is one to which we cannot agree. And thus we find that—trimmings apart—the *essential* requirements in planning a stage in an amateur hall are identical with those in a normal small theatre. These essentials we shall seek to establish in what follows.

Thus, to amateurs designing a small hall we would say: Though you will find that this book includes a chapter on your particular problems, the whole book has been designed with your needs in mind, for above all theatres, yours can least afford to dispense with what is really essential, and if we seek to discuss essentials in stage planning we cannot do better than to take your hall and its difficulties as our starting point.

If we do not here enter into any discussion of the equipment of your hall, such as its scenery, lighting gear, *et cetera*, that is because books on these subjects are available. It is up to you to add to those necessities which you recommend to your architects such furnishings as will best help your particular type of work. We claim only to give you something into which such furnishings can be fitted efficiently, and where an audience can be accommodated without disgrace.

GENERAL PRELIMINARIES

Turning now to the opposite end of the scale—the large capital theatre. Here again so far as concerns basic essentials of stage planning, we can find no reason for any change of principle. Scale, detail and specific equipment may vary greatly, but, as with the amateur hall, we have not found it come within our present province to add to the information on these subjects in the specialist studies that have been made—though we may join with others in bewailing their rarity. But for these matters there are experienced specialists in all departments available to be consulted and to undertake research; the problems are many, as the National Theatre Committee has already found in its investigations. But the task of such a theatre is at least clear—namely, to make the best application possible under modern conditions of classic tradition. The essentials of stage planning that we describe are consistent with this tradition.

It is a somewhat different matter with the third type of theatre—the theatre designed for experiment with new forms. Here classic precedent may be the last thing that is sought. But experiments are never worse for a knowledge of the tradition from which they diverge, and, generally speaking, all that is *essential* in an ordinary type of stage is essential also in any experiment. All such experiments we watch with the greatest interest, and favour the testing of all new forms, but in this book we must—maybe somewhat regretfully—leave the experimenters and keep to the broad highway.

Finally, concerning the fourth type of theatre—that form which seems increasingly evident in plans for the future—where an attempt is made to produce a shape of stage and auditorium that is consistent with the requirements of production styles of various periods, we shall have something to say of this in the body of the book. For the moment we need merely remark that here a codification of essentials is clearly as urgent a pre-requisite as in any form of theatre planning.

This last form of theatre brings out more clearly, perhaps, than any other the importance of considering the best layout of audience for any given type of stage. Here again is a field for special research, but we must observe that any theatre—whether in a small village hall or a large professional building—has two main parts, a stage and an auditorium. A well-designed auditorium is one where a given number of people can witness to best advantage the performance upon the stage. But the design of an auditorium must follow after the design of the stage. The stage is the basic factor in the design of any building in which stage performances are to be

ESSENTIALS OF STAGE-PLANNING

given; it is the nucleus around which the whole of the rest of the building should be organized.

The stage, moreover, claims first place in our study for another reason. For most architects the business of the stage is a hidden world. The auditorium is something an architect can visit and of whose shortcomings he may easily be aware through experience, but the demands of the stage are special and almost secret. They arise from the business of a particular craft, and to understand them one must have at one's disposal experience in that craft. It is not easy to avail oneself of such experience without practical knowledge of the stage; the fruits of stage experience can, however, be codified and offered to the architect in general terms. This the following study attempts to do.

With such an approach, then, we concentrate on the stage; and the type of stage on which it has seemed most useful to base our discussion is the reasonably-equipped stage of a specially designed theatre built to accommodate about 500–700 spectators. (To the point of the phrase 'specially-designed' we shall return in a moment.)

The *essentials* of planning such a stage are in the main, as we have shown, the same as those of a village hall or school stage on the one hand, and of medium and large professional theatre stages on the other. When the points are only applicable after some modification to these other theatres, a note will be added to that effect in the relevant place in the book.

Those to whom this book is addressed include the ever-eager amateur, who contrives to number among his fellows some who are completely ignorant of the essentials of stage planning as well as some with the most surprising grasp of even its more specialized complications; many of the best as well as of the worst little theatres of our time are amateur theatres.

Most especially however we address those individuals upon whom the main responsibility of creating a theatre falls—the architects. To them, clearly, our first duty lies. But in this connection we must also have in mind those to whom it falls to instruct the architects. To such we make a special and personal observation:

Because of what has been said about the value of actual stage experience, it clearly cannot be expected of an architect that *he* should instruct *you* on the design of a stage. The building is a specialist matter, and too few theatres are built for more than a small number of architects to be justified in including such specialist research in their already extensive study. It must be understood that *it is not the business of the architect to know the inner*

GENERAL PRELIMINARIES

details of stage requirements. It is the business of those who employ the architect to see that this knowledge is put at his disposal. To do so, the employers may either themselves clearly understand and impart to the architect what they require of a theatre, or they may obtain the services of an experienced specialist to do it for them in consultation with themselves and with the architect.

Even here the duties of the consultant are hard if the employers do not clearly know what kind of a theatre, and what kind of stage productions, they wish to create; and it will be part of the consultant's duties to get these two questions clear with them before he goes to the architect. Further, he will have to satisfy himself upon the future of that theatre and of the calls likely to be made upon it by the development of new styles of presentation. It is too easy, on the one hand, to omit a valuable feature because limited experience sees no future for it, and, on the other hand, to include a momentarily popular device which practice will prove a white elephant.

In the case of large theatres, a further specialist who may find useful information in this book is the consulting engineer. It would appear that on some occasions an architect passes over to the consulting engineer, for detailed specification, a number of subjects such as heating, ventilation and wiring, *and also stage lighting and stage equipment.* For these latter subjects, specialized theatrical knowledge is essential.

And now a final but most important distinction before we turn to discuss the first steps in stage-planning.

The authors having decided to concentrate the bulk of their attention upon the stage of a proper theatre, some definition of this phrase is needed. The building ideally envisaged in this book is one that is designed specifically as a theatre, in contradistinction to what may be called the dual-purpose, or multi-purpose, hall with a flat floor.

There appears to be a rising tendency to put forward the claims of the multi-purpose hall as a general solution of the many demands made upon, say, a community centre. It is, however, our opinion that any hall intended to be used with the minimum of re-arrangement as dance-hall, gymnasium, school hall, exhibition room, et cetera, *and also as a theatre,* cannot properly serve this dual purpose; *for upon a flat floor no audience can be properly arranged in relation to the stage.*

Certain compromises have admittedly been found to this problem—as will be noticed later—but if the spectator is to be comfortable and able to concentrate on what is taking place on the stage, it is essential that the seating

ESSENTIALS OF STAGE-PLANNING

should be arranged so as to permit the least obstructed view. A flat auditorium floor does not permit this and it increases the difficulty of the actors in 'putting the show over'. It is therefore not good theatre design.

We have left this point till last in our introductory remarks partly to emphasize its importance as a (we hope temporary) danger, and partly



Fig. 1. 'Many a notable theatre has developed from most unpromising raw materials.'

because we shall be immediately faced with it in our first examination of the essentials of stage-planning in the next chapter.

This first examination touches two of the most elementary fields where planning is needed in stage design; the adaptation of an existing building to some simple form of theatre, and the initiation of a new building specially

GENERAL PRELIMINARIES

for the purpose in a typical small community. There are certain vital requirements to be understood here and the understanding of them will stand us in good stead in stage-planning on any scale.

Let us first take a group of beginners in a new theatre venture and watch their examination of a prospective building for adaptation to their future home. A considerable responsibility lies upon them.

NOTE TO THE READER

The reader may refer to p. 96 for a guide to the meaning of any technical terms used in the following chapters. There, an alphabetical list of terms will be found with a reference number against each. Where no figure number is given after the reference number, the object will be found in the group of illustrations (Figs. 57-59) immediately following the list. Where the term is, however, illustrated elsewhere in the book (as, for instance, in the drawing of details in Fig. 15) the appropriate figure number is added after the reference number in the list.

CHAPTER TWO

SMALL AND MULTI-PURPOSE HALLS

(a) Adapting Existing Space

WHEN you pass the plans for a new stage you are affecting the future of a number of people. Whether they be players or playgoers, the conveniences and inconveniences of that stage will influence the kind of theatrical work to be done, or the kind of theatrical impressions to be formed. The plans will not decide whether the work will be good or bad—it takes more than a stage to decide that—but they may very materially affect the amount of sweated labour which those who can achieve good work on the stage will have to spend in getting it.

Though an experienced company under a good producer may triumph on a poorly-planned stage, a group of beginners may have their future development crippled from the start. Moreover, the amount of unnecessary, sheer hard work which their triumph will cost the more accomplished may bring even them in the end to exhaustion. There is a limit beyond which even genius will not work. Many stages set just that limit.

A well-planned stage is to a good company what a fine car is to an accomplished driver; it affects the performance. Yet a well-planned stage may be very simple and possibly fairly small.

The essentials in stage planning are simple things. The complications which may develop in a theatre—either for good or ill—are generally not concerned with essentials, but with specialities. But, however simple an essential may be, to lack that essential must spell inefficiency. There is no substitute for an essential.

Let us see how simple the real essentials of a stage are.

In any building large enough to accommodate an audience, a platform for the actors and two dressing-rooms and a lavatory, and with height sufficient enough to allow 2 ft. 6 ins. clearance above the actors' heads, it is possible to present theatrical performances. Lack of more specialized facilities is no bar to beginners, and many a notable theatre has developed from most unpromising raw material. It is no doubt encouraging for

SMALL AND MULTI-PURPOSE HALLS

beginners to know they can do much with little, but a building which aims at something more than to make performances just possible—which is to offer its users a chance of progressing and developing—needs very careful planning, especially, if it is small.

Imagine a group of enthusiastic people in a small town seeking for premises where they might begin a theatre. What must they look for?

In the first place, they must decide whether the room or hall, or whatever it be which they have in mind, can accommodate the actors' platform which we mentioned. Our friends stand in the hall and one of them goes forward with a tape and measures its width. The first essential question is now asked: Will the existing hall permit an adequate-sized stage?

It might appear that the definition of an adequate size for a stage is too relative a matter to lay down rules. There is, however, the following very useful and practical guide to the minimum size of an adequate stage: During the war, in order to decide the minimum size for a standard travelling fit-up, the Ensa Equipment Division instructed its most experienced theatrical members to decide the smallest effective area on which entertainments could be performed in Navy, Army and Air Force camps. After considerable experiment in the most varied conditions, it was agreed that, for general purposes, no performance, either of a play or a variety show, could be adequately presented in an area under 14 ft. wide by 10 ft. deep, and, further, that the business of working a show could not be adequately carried out unless wing spaces of 3 ft. were allowed either side this acting-area, and a passage 2 ft. broad behind it.

Thus the overall figure for a practical stage, even in such adverse circumstances as Ensa had often to face, was fixed at 20 ft. wide by 12 ft. deep (see Figs. 2 and 3). And we may suggest to our group of explorers that a building that allows less than a 20 ft.-wide stage will impose almost insurmountable difficulties upon the company working therein. At this point it should be emphatically added, concerning these Ensa measurements, that they permitted the presentation of only limited types of plays and variety turns. They represented an irreducible minimum, but never professed to be adequate for shows involving changes of scenery—all they covered was the type of stage with a permanent surround of curtains—and we shall find reason to modify the measurements when we come to consider the planning of stages in detail in Chapter 3. Fig. 4 illustrates the working details of the final fit-up. Though our concern in this book is not with the equipment, we

ESSENTIALS OF STAGE-PLANNING

include this example as one of the few fit-ups that require no attachment to walls or ceiling.

The minimum height for a room in which an adequate stage can be put is 12 ft.—allowing 3 ft. 6 ins. for the stage height from the floor, 7 ft. for the

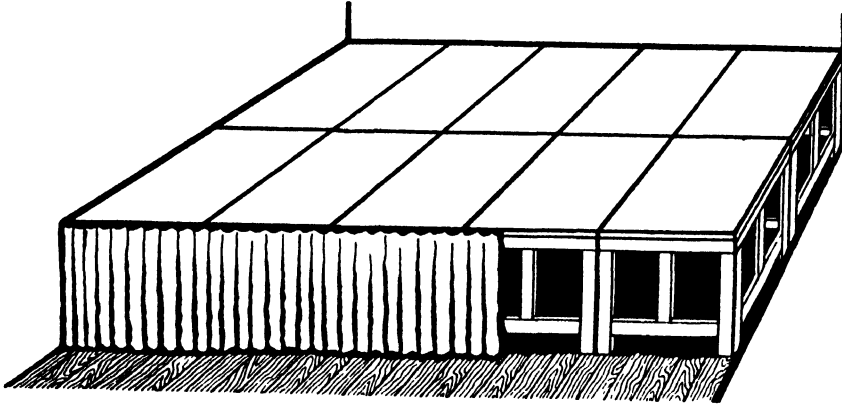

Fig. 2. Temporary Stage of 6 ft. by 4 ft. Rostrums. A 20 ft. by 12 ft. stage in ten units. (Adjacent legs are bolted together.)

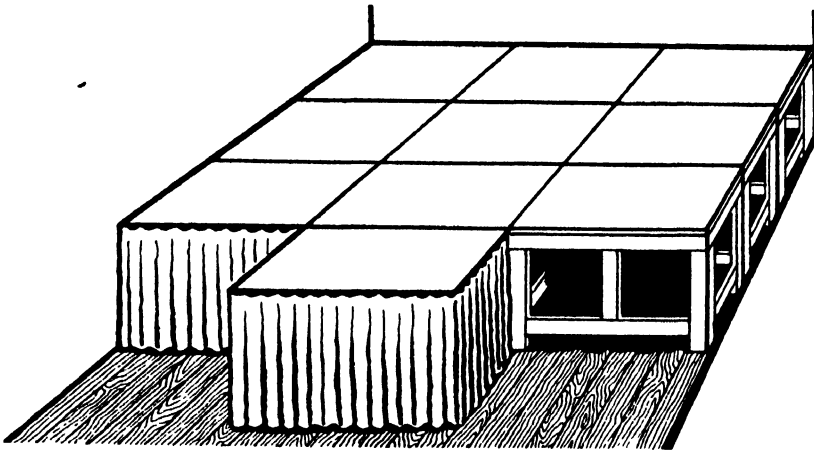

Fig. 3. Temporary Stage of 7 ft. by 4 ft. rostrums. A 21 ft. by 12 ft. stage, with small forestage, in ten units.

stage opening, and 1 ft. 6 ins. above that for hanging material, masked by the pelmet or proscenium top. It is important to see that this 12 ft. of height is clear throughout the hall; one of the greatest obstacles to working a stage is a roof which, at the sides, slopes down to join the walls at a level less than 12 ft. up from the floor.

Having now established the area of floor-space which must be occupied

SMALL AND MULTI-PURPOSE HALLS

by the stage, and the height from floor to ceiling, our group next turns about to survey the possibilities for an auditorium.

Their guide here is the unit-space allowable to each seated person, and this space is 1 ft. 6 ins. wide by 2 ft. 6 ins. from back to front. The L.C.C.

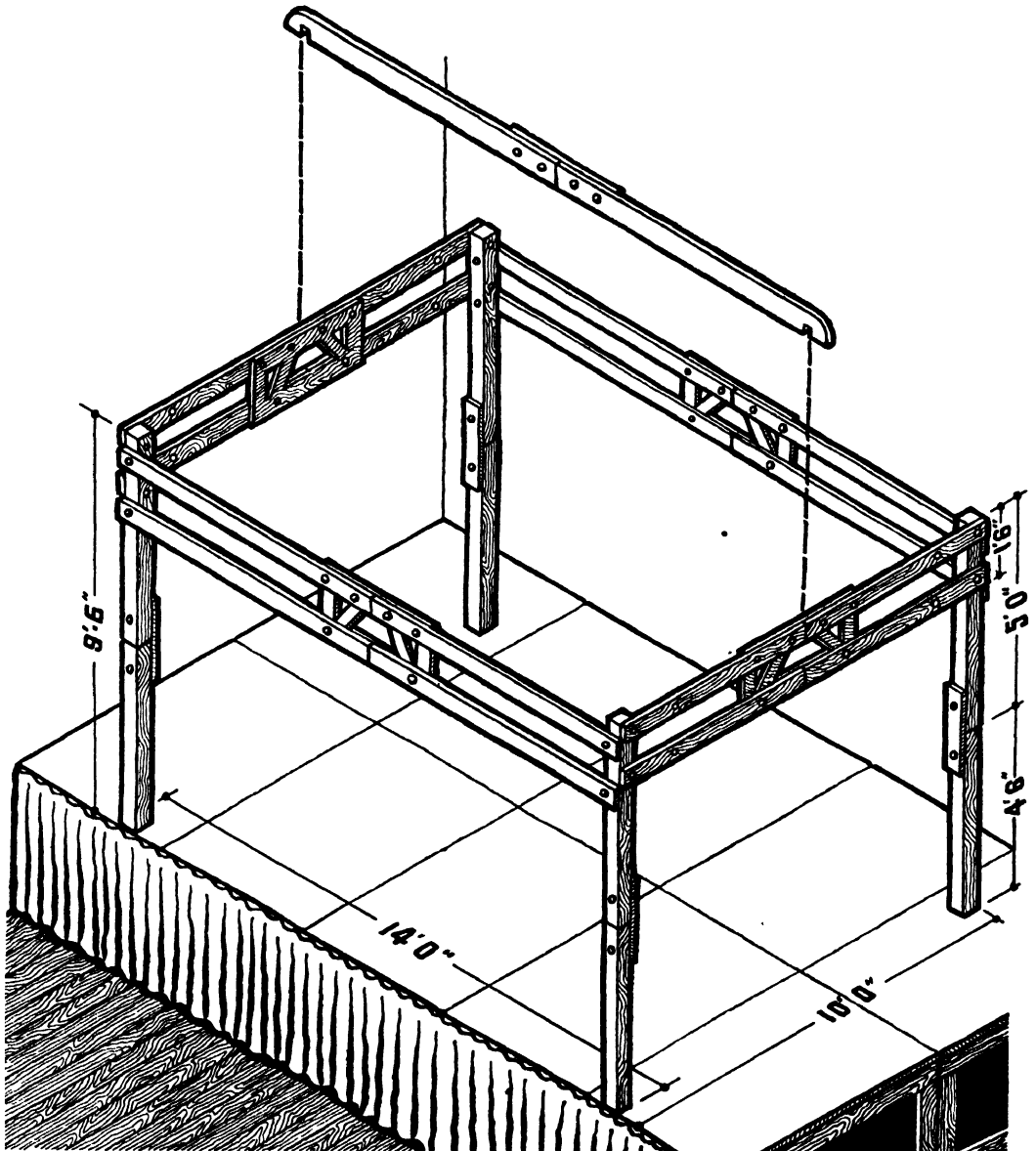

Fig. 4. The Ensa Fit-up. Designed for use where no fixtures to ceilings or walls are possible. The uprights and the cross-pieces are hinged centrally. Curtains are hung round cross-pieces, while uprights are 'kneeling' at half height on stage. The whole is then raised to full by four men and the hinged legs battened out.

ESSENTIALS OF STAGE-PLANNING

regulations specify: 'The seating area assigned to each person shall be not less than 2 ft. 6 ins. deep where backs are provided and not less than 2 ft. deep where backs are not provided and shall not be less than 1 ft. 8 ins. wide where arms are provided and not less than 1 ft. 6 ins. where arms are



Fig. 5. Fit-up using Existing Features of Roof for Support.

not provided.' Some gangway must be provided for access to the rows, and though two side gangways take more room than a single central aisle, they afford the audience better sight-lines (see Figs. 6 and 7).

(It must be said here, though we are at the moment only exploring preliminaries, that in many localities very definite regulations govern the relation of gangways to seating and many other matters. Such regulations apply only to theatres where what are called

'public performances' are given, but the fact that a private club theatre (where the audience is limited to members) is not touched by them should never be the excuse for the designers ignoring the wise provisions for safety which they embody. Since regulations of this nature are not standardized throughout the country; we cannot easily discuss them here, but it is incumbent upon each designer to make himself thoroughly familiar with those which apply in his case. It seems, moreover, that all stage- and theatre-designers, whatever their part of the country, will be well advised to be conversant with the following two publications of the L.C.C.: No. 3,398. *Places of Public Entertainment—Protection from Fire* (1939), price 6d., and No. 3,522. *Places of Public Entertainment* (1947), price 1s., both obtainable from Staples Press Ltd., 14 Great Smith Street, Victoria Street, S.W.1.)

To return to our group; if they find themselves in a 20 ft.-wide hall, they will see at once that to allow two 3 ft.-wide gangways will leave them a 14 ft.-wide space for the rows of seats. This 14 ft. will permit ten and a half seats, which, as the rows must be staggered (that is, each chair set so that it is behind the interval between the two in front; see Fig. 8), allows exactly ten seats to a row.

SMALL AND MULTI-PURPOSE HALLS

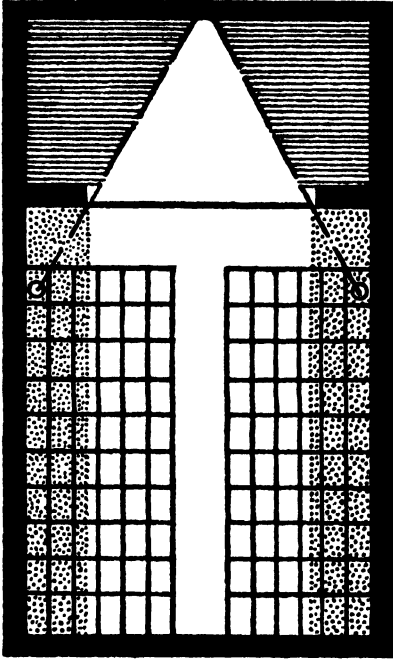

Fig. 6. Gangway Sight-lines. The inconvenience of a central gangway for sight-lines. Shaded areas represent poor visibility.

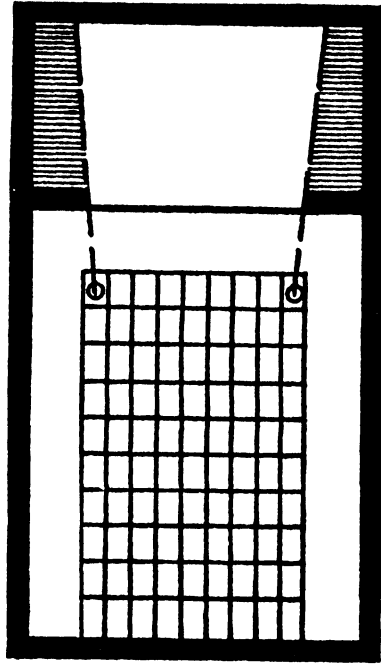

Fig. 7. Gangway Sight-lines. Though the audience is now smaller, a greater number of seats have a good view.

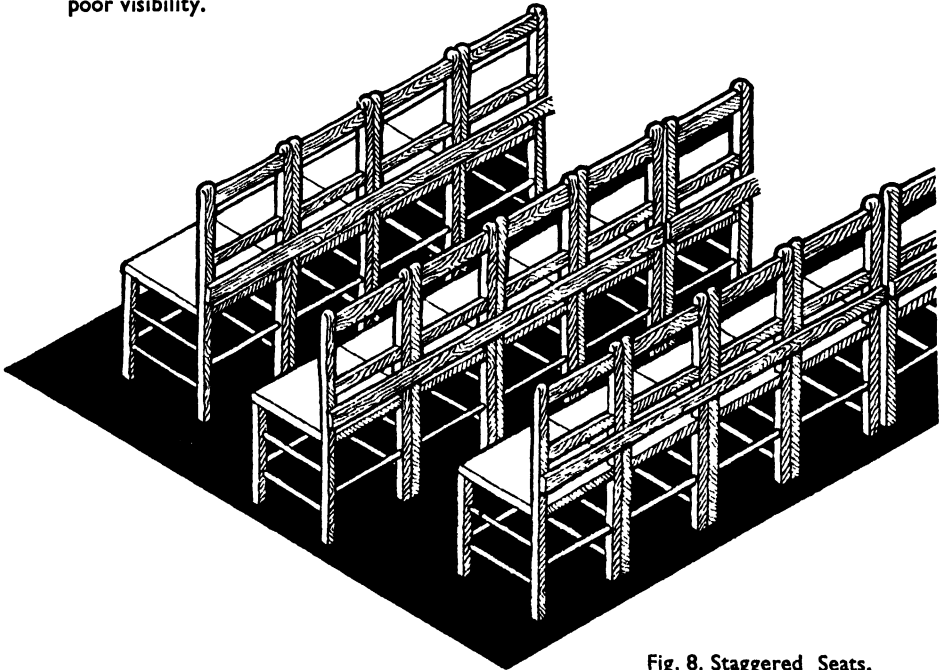

Fig. 8. Staggered Seats.

ESSENTIALS OF STAGE-PLANNING

The group proceeds up the hall to estimate the number of rows so as to judge the size of their audience. On the way they will encounter possibly the most important single factor concerning the disposition of seats in any theatre. The function of every seat in an auditorium is to allow a spectator to sit and see the show. Our investigators will find, if they are careful and candid, that after the fifth row a difficulty arises in seeing the stage, *and that this difficulty increases with every row they go back.* The heads of people in the front rows will get in the way (see Fig. 9). So, and this is a matter of fundamental importance, if the function of the auditorium is to make it possible to

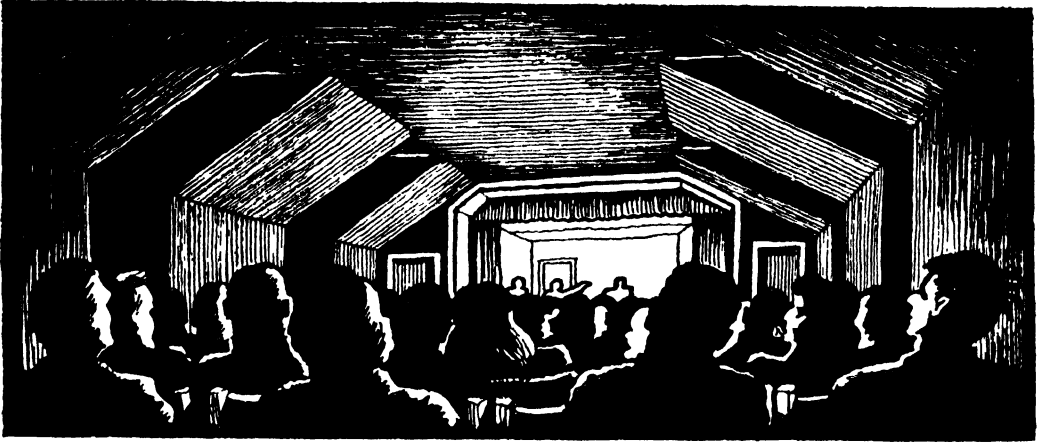

Fig. 9. 'It is no good building a stage if you can't see it.'

see the show, then any seats beyond the fifth row must be built up in some sort of a progressive eminence—either on a series of steps or on a slope.

Let us stop for a moment and consider what is at issue here. It is no good building a stage if you can't see it. The most efficient arrangement of space and equipment on the stage is of little help to your theatre if the people cannot see, *and see without straining.*

Some people seem to have the idea that a comfortably-positioned seat in a theatre is a luxury. It is not; it is a very real business necessity. Notice we are not at this moment concerned with merely a *comfortable* seat. People will, on occasion, suffer a lot of discomfort to *see* a good show, but no single sane person on earth will pay money to be uncomfortable and *not* see the show. He will just walk out, or stay away next time.

Frequently, at war shows performed in temporary auditoriums, troops who left before the show ended were questioned: Did the performance bore them? And the answer would come: 'The show may be all right, but *we just*

SMALL AND MULTI-PURPOSE HALLS

can't see it.' Those were men who had been sitting in the middle and back rows of a flat-floored auditorium.

But there is another equally important point. A flat-floored auditorium closely affects the players too, and, through them, the show. How can an actor put over the meaning of a part when his actions cannot be clearly seen? The majority of the audience simply do not get what the actor has to offer and what, to speak honestly, they have paid their money for.

As things go to-day, it is harder work to go to many theatres than to any cinema. This is by no means only because the content of a play is fuller than the content of a scenario; but rather because it is far more difficult for most people to observe what is happening on the stage, and so put all the subtleties of the story together, than it is to see what is happening on the screen where the bottom of the picture can be many feet from the floor, and where the 'stage' has no depth whatever to complicate the sight-lines. To raise a live stage to a similar height would be to cause the front rows to see the players too acutely from below and to lose the lower half of any actor up-stage. Even with such differences, it is significant to notice how few, even of the poorest cinemas, have flat floors.

We therefore ask that any group contemplating the adaptation of a hall into a theatre shall bear in mind that beyond the fifth row you cannot properly see the stage unless the seats are raised. All efforts to plan their stages will be half-wasted if they fail to attend to this.

The next essential is dressing-accommodation. If there are not already two adjoining rooms suitably placed for the purpose, then the dimensions of the building must be such as to allow of their being added. A wide site may permit one dressing-room to be built on either side beyond the wing-spaces. A long site may permit of the stage being deepened and dressing-rooms being built on it at the back.

Further, it is desirable that the players should be able to reach the dressing-rooms from the street without going through the auditorium. Lavatory accommodation is absolutely essential.

Beyond these fundamentals we can go very far indeed, but to come to rock bottom these are the essentials of a theatre, and lacking any one of them an adequate theatre is impossible.

We may round off this passage and lead into the next with two illustrations. Fig. 10 gives an example of the simplified adaptation of a typical village hall. It shows no more than a first-aid solution and is marked by the disadvantages consequent upon such half-measures, but it does show some

ESSENTIALS OF STAGE-PLANNING

approach to a solution. To supplement this, we show in Fig. 14 the same hall, but now adapted with a firmer grasp of the difficulties. Chief among the adaptations are the provision of a stepped floor by excavation, and of head-room by building dormer shapes out from the roof. An optional extension of wing-space is also suggested. The result is a not-inadequate Little Theatre.

(b) Initiating a New Community Theatre

Before, however, we go on to consider the details of such planning, let us consider the case of a group of people who are envisaging the erection of an entirely new hall which is wholly or partly to be used as a theatre. As likely as not, they will be the committee of a Civic or Rural Council, or of an Educational Authority entrusted with building a school hall adaptable also for theatrical purposes. Such a Committee are differentiated from the normal amateur group by two factors; public duty and public funds. Upon their foresight and wisdom depends the work of other people whose interests it is their duty to safeguard and promote. Their relation to the financial side is also quite different; they have larger resources and are in the position of business men investing money for which they stand trustees.

They have first to ask: Who will give the theatrical performances in the building they are about to bring into being? A community of the sort we suggested may be entertained by local or visiting amateurs or by touring professional companies, or both. And as a result of the work of the Arts Council of Great Britain, and of others, the likelihood of the increase of visits to small (and large) localities by professional companies who, because of the quality of their work, are in many cases officially sponsored, is a very immediate matter and as near as may be a certainty of the future.

But it is quite possible that this excellent scheme may break down purely on account of badly-planned stages which put such difficulties in the way of the companies that it will be increasingly difficult to persuade good actors, however enthusiastic, to put up with conditions making it impossible for them to give their best. This passage from a letter suggests something of these difficulties: 'This tour is killing us. Give me the tattiest B stands or rep. season rather than the hell of grinding all day trying to fit the show into the most appallingly awkward buildings, re-rehearsing moves and entrances because this or that bit of scenery can't be used, and being so fussed and exhausted by the evening that it is impossible to play one's part properly.' Professionals require a stage containing the simple essentials which will enable them to put on an adequate performance.

SMALL AND MULTI-PURPOSE HALLS

Now, such a stage is the same stage as good amateurs require. There is no difference. The better a stage is planned and equipped, the greater the scope of a theatre's programme.

The most elaborate item of mechanical equipment on an ordinary modern stage is the scene-flying system, and this may be a costly matter. But there are two alternatives here. A useful stage may be built either with or without flies (see Figs. 11 and 12). The two alternatives are discussed later in this book, and after considering the relevant sections the public body with whom we are here concerned will have to make a decision for or against their inclusion in the theatre.

These matters being disposed of, the next fundamental decision has now to be made: Is this theatre to be used exclusively as a theatre, or must it at times be adapted to other purposes?

This raises the same problem which has already proved troublesome to our first group, for it concerns the nature of the auditorium floor. We have established that a theatre floor cannot be flat. But for almost every non-theatrical purpose to which a public hall can be put, a sloping floor is a positive

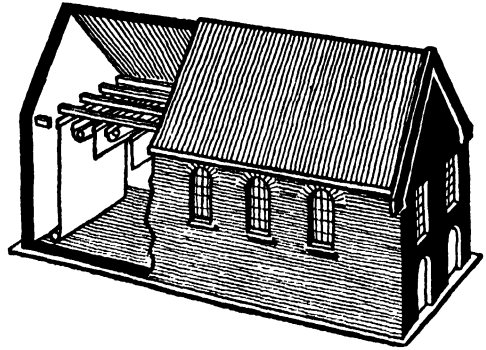

Fig. 11. A Small Theatre with no Flying Space, showing how the scenery is suspended from bearers over the stage. All back-cloths have to be rolled.

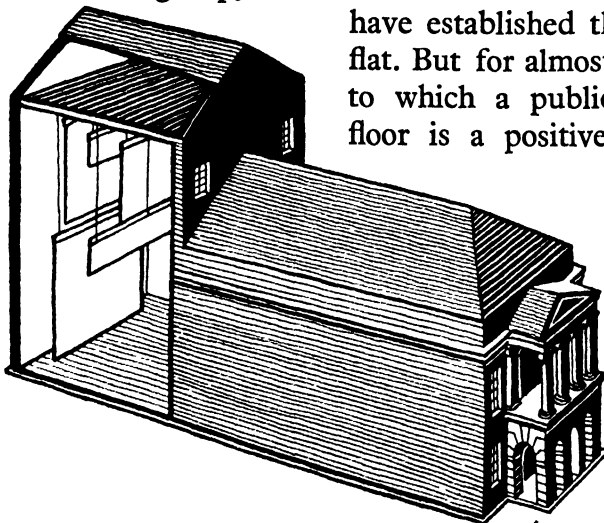

Fig. 12. A Similar Theatre, but constructed with a Fly-loft into which back-cloths (et cetera) can be drawn up without rolling (for files, see Chapter 4 Section b).

disadvantage. We are thus brought face to face with the vexed question of the Dual-purpose, or Multi-purpose, Hall, and the matter is further complicated by the fact that many Councils, though prepared, and maybe eager, to see their hall occupied by professional theatre companies from time to time, yet know that such occasions will be few and far between.

During the rest of the year their hall must lie idle (save for occasional amateur use) or be put to entirely different employment—as for exhibitions,

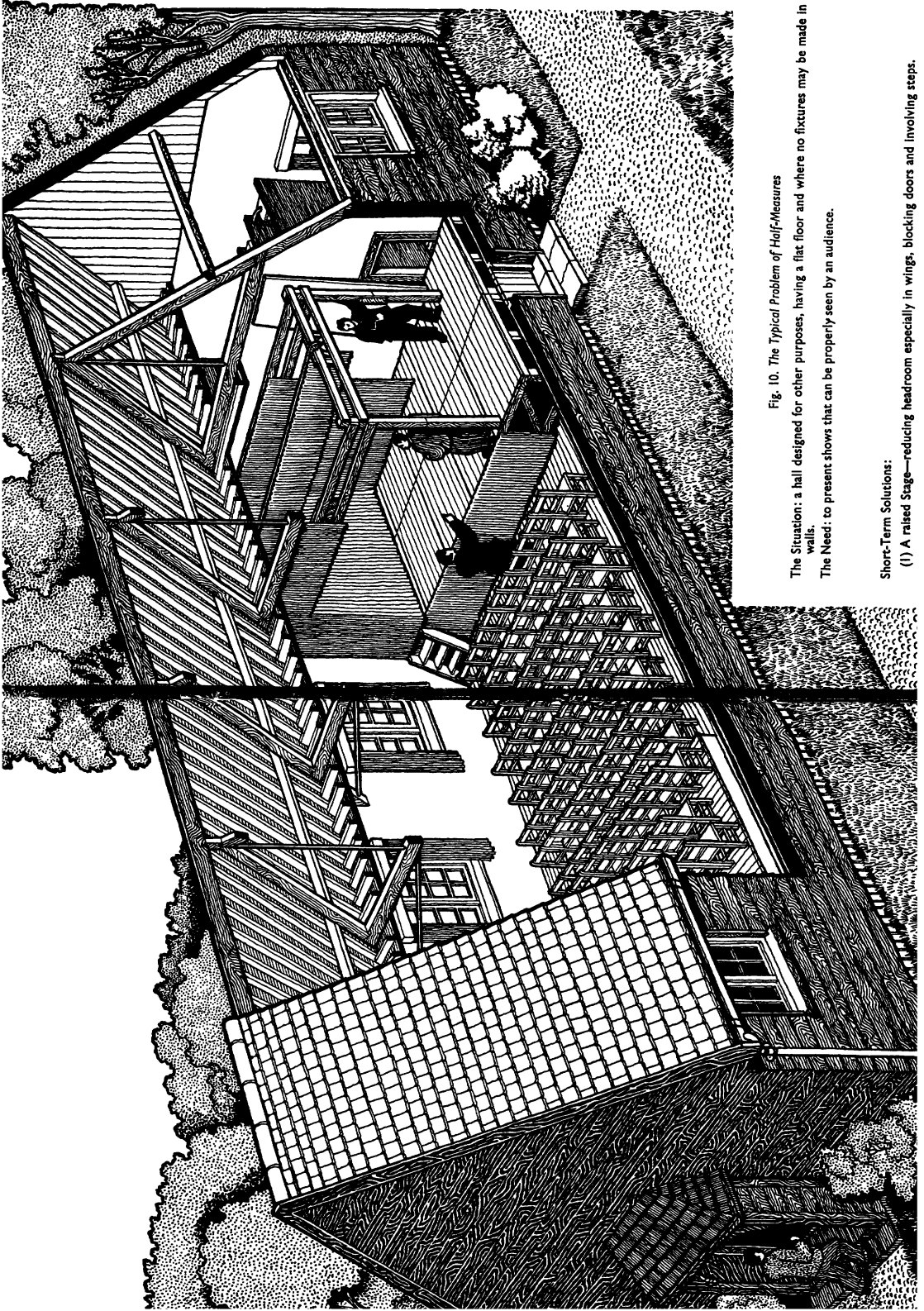

Fig. 10. The Typical Problem of Half-Measures

The Situation: a hall designed for other purposes, having a flat floor and where no fixtures may be made in walls.

The Need: to present shows that can be properly seen by an audience.

Short-Term Solutions:

- (1) A raised stage—reducing headroom especially in wings, blocking doors and involving steps.

ESSENTIALS OF STAGE-PLANNING

bazaars, meetings, whist-drives, and so forth, all of which demand a flat floor. Exactly the same situation faces many educational authorities who wish to provide an adequate stage for school use, yet cannot afford to ignore the chance that the space offers for a gymnasium or an assembly hall which, however, demand, in absolute contradistinction to the theatre, a flat floor.

Now, this is no new problem. Exactly the same requirement for a multi-purpose building confronted theatre-designers in the small towns of England in the eighteenth century. Then, circuit theatres were occupied for only a fraction of the year by the touring companies, and the buildings since they were often municipally owned had to afford some revenue in the remaining months instead of lying idle. The solution they formed was logical and effective. Instead of devising a general-purpose hall, we find that the more specialized building, the theatre, is conceived first, and its adaptation to secondary uses comes afterwards. In the country-town theatre of the eighteenth century the capacity for adaptation was achieved by very simple means which obtained in buildings as different in size as the tiny Georgian theatre at Richmond, Yorkshire; the Theatre Royal, Bath; the Opera House, Haymarket; and Covent Garden itself. The method adopted was the boarding-over of the sloping pit by a temporary floor on a continuous level with the stage; and it may be seen in use to-day whenever the stalls at the Albert Hall in London are boarded over so as to turn it into a vast ballroom.

The suitability of the resulting 'general-purpose hall', with its gallery and other offices of a theatre, may be seen by any interested person who studies the photographs of the Richmond (Yorks.) theatre before its recent restoration. The possibilities of the idea are indeed only limited by the amount of time and labour that must be involved in laying, or taking up, this temporary floor.

But even this last objection is to-day removed with the advance of engineering and the application of new materials. A scheme has actually been devised whereby the entire change-over from a raked theatre to a flat hall can be effected in a matter of minutes and with the attention of no more than one man.

Several suggestions have already been made for rising and falling floors, but there has lately been published, by possibly the most experienced firm of stage machinists in Britain, in their new handbook on stage equipment, a simple system in which a floor is built not on joists, but, like a roof, on trusses. A suggestion of the principle may be given as follows: imagine the

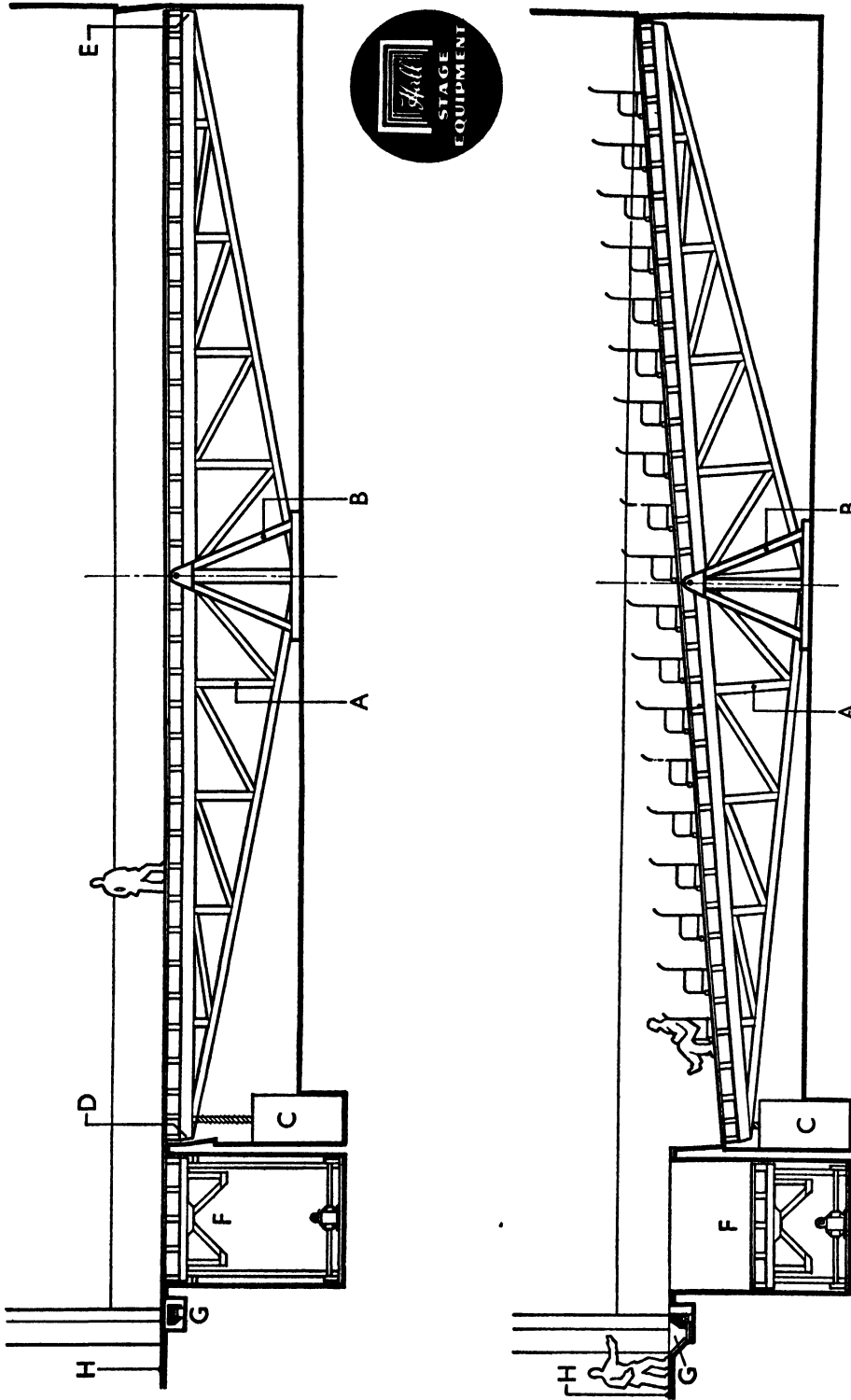

Fig. 13. A Scheme for a Dual-purpose Auditorium Floor. (A) Steel trusses on which floor is pivoted. (B) Brackets on which floor is pivoted. (C) Screw and motor for varying slope of floor. (D and E) Locking bolts to ensure rigidity. (F) Variable floor to orchestra well. (G) Disappearing footlights. (H) Stage.

ESSENTIALS OF STAGE-PLANNING

system of triangular trusses in a normal steel-skeleton pitch roof—that is, a roof sloping down either side from a central ridge; turn the whole system upside down so that the apex is on the ground and the flat tie-bars on top, and build the floor on the tie-bars. The whole will now tip like a see-saw about the centre-line of the ridge (see Fig. 13). Bolt it in position horizontally at a level with the stage and you have a continuous flat floor. Clear the floor, withdraw the bolts, switch on a small motor to draw the see-saw down and you have the basis of a raked auditorium, where rows of chairs with specially-compensated front legs will finally convert the building (if it is adequately designed in other respects) into a proper theatre.

There remain practicalities. Any technical points will be best treated by the designers of the system, the Hall Manufacturing and Supply Company Ltd., Nona Works, Wynne Road, Brixton, S.W.9. Concerning the cost of such a scheme, let us put a simple question. Suppose it to cost £1,000 more or less. An equally-efficient theatre may then be built without it for £1,000 less money; but the owners of that theatre, since it has a fixed, sloping floor, will have to erect a second building if they want also to cater for extra-theatrical requirements. Will that be done for £1,000?

If, however, they provide a single floor that can be adjusted to support several different sorts of activity, all they need can be included in one building. They will be following the lines of normal and logical, English, small-theatre tradition. They will be bringing tradition up to date by applying improved modern resources to perennial needs. And they will possess what in the authors' opinion is the only sound and practical form of Hall-cum-Theatre. All that is needed now is the initiative for the experiment.

Fig. 14. Improved Adaptation of a Small Hall. Long-term Solutions (compare Fig. 10)

- (1) Stage at Ground-level, with—
 - (2) Dormer Shape in Roof—giving 22 ft. from stage to 'modified grid', leaving doors free and obviating all steps.
 - (3) Hanging Fit-up—permitting modified flying, and variety of set-shape.
 - (4) Excavated Pit for Audience—allowing seats to be on rake, and leaving existing entrance. Sunk section raised to level floor on occasion.
 - (5) Screen through Dressing-Rooms behind back-wall—giving passage across, and allowing plastered back-wall for cyclorama-effect if required.
 - (6) Optional Addition to width of Stage—giving increased wing-space.
- A. Vestibule, et cetera.
B. Back section of auditorium floor at stage level; remaining sections stepped down to front.
C. Section of ceiling.
D. Level to which floor is raised for general purposes.
E. Chairs battened in fours.
F. Front Curtains forming proscenium sides.
G. Proscenium border.
H. Scene door.
I. O.P. wing-space.
J. P.S. wing-space.
K. Batten being attached to lines.
L. Footlights.
M. Door to dressing-room corridor.
N. Proscenium, or No. 1, light batten.
O. Cyclorama.
P. Sky batten.
Q. Dormer shape in roof to accommodate flies.
R. Bearer for centre-line pullies.
S. Bearer for short-line pullies.
T. Bearer for head-blocks.
U. Descending ends of a set of lines.
V. Row of cleats for tying-off lines.
W. Back-wall of stage.
X. Dressing-rooms.

BACK STAGE DETAILS

Fig. 15. Back Stage: showing left-hand side of scene and part of back-scene. Viewed from the back, left-hand corner of the stage, and looking down the wing-space toward the proscenium and the Prompt Corner. This diagram and those following p. 96 are intended together to provide a full pictorial glossary of all technical terms used in the book, and the relation of each with the others and with the stage as a whole.

ALPHABETICAL LIST OF TERMS ILLUSTRATED IN FIG. 15

(For full list of illustrated terms see page 96)

Act Drop, 1	Hanging iron, 40
Backcloth, 2	Lead, 52
Backing, door, 3	Lead-off steps, 53
Backing, fireplace, 4	Length, 54
Battens stiffening a wall of flats, 6	Line (throw-), 55
Brace, extending, 10	Pack (scenery), 60
Brace, french, 41	Prompter, 63
Brace weight, 12	Property table, 65
Bridge, 14	Proscenium border, 86
Bridle chain for heavy batten, 13	
Ceiling, 15	Return, 67
Cleat, 18	Rostrum, 68
Compartment batten, 87	
Dip, 25	Sandbag, 71
Door backing, 3	Scenery pack, 60
Fire flood, 30	Sill iron, 73
Fireplace backing, 4	Snaphook, 74
Flat, 32	Snatchline, 75
Flood, 33	Spot on stand, 78
Fly-floor, 37	Stage cloth, 79
Foliage border, 38	Stage manager's desk, 80
French brace, 41	Stage screw, 81
French window, 43	Switchboard, 82
Front curtain, 44	
Groundrow, 46	Thunder sheet, 83
Grummet, 47	Tripe, 84
	Wind machine, 85

CHAPTER THREE
THE STAGE FLOOR

AFTER these preliminaries, let us turn now to the main subject of this book—the stage—and to the consideration of those prime conditions which must be observed if the result is to be satisfactory, whether it be in the smallest hall or in the larger general-purpose theatre.

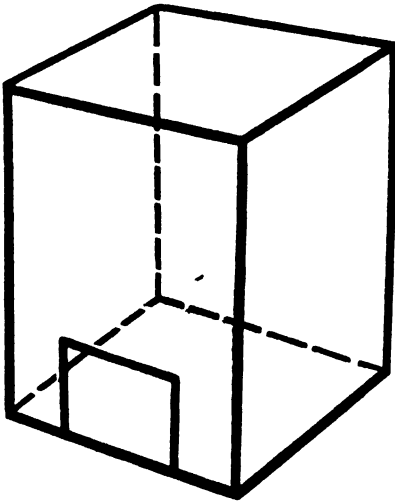

Fig. 16. The Six Sides of the Cage.

Now, the stage of a modern theatre may be likened to an empty cage (see Fig. 16). It consists of a floor, four sides and a roof. That the fourth side or wall, which divides the stage from the auditorium, may appear to be non-existent, or nearly so, makes it none the less important from our present point of view.

It is the floor of the stage which provides, like that of a cage, the surface upon which all the activities of the occupants are mainly based, and here we begin our study.

(a) *Stage-level*

In general, the stage should not be conceived as a raised platform but merely as a floor area at zero level. To confine oneself to the idea of a raised platform is to risk overlooking the fact that the most advantageous level for a stage is, in fact, zero—that is to say, at ground level or street level, and that the remainder of the theatre should be conceived above and below that level.

The architect Ernest Runtz, F.R.I.B.A., F.S.I., designer of the Century Theatre built on the site of the Adelphi in 1901, wrote in an article, on 'Theatre Design and Construction' in *The Stage Year Book* for 1913:

'It is usual that the stalls level of the theatre should be sunk some distance from the pavement level, the advantage of this is that the

THE STAGE FLOOR

means of egress from all parts is thus within the shortest possible distance of the street level, apart from which much valuable space underneath the pavement is usually permissible by arrangement with the authorities.’

A stage at ground level means an excavated pit for the auditorium, but as we have seen, an auditorium-floor should slope in any case and it may be easier to excavate a pit with an inclined floor than to build the stage at a higher level and then, perforce, construct a framework to carry the sloping auditorium, all above ground. The matter is closely dependent, of course, upon the kind of ground upon which the theatre is to be built.

This attitude frequently marked English theatre-design in the past—even in so small a theatre as the private, amateur one of the Duke of Richmond adapted by Wyatt, of which *The World* (January 23rd, 1788) said: ‘The Stage is the floor—and the Orchestra is sunk into the room below it—and so, in the same manner is the Pit.’¹

The advantages of a stage at street or ground level are (see Fig. 17):

- (a) The obviation of ramps, steps or lifts for ‘getting-in’ scenery and baggage,
- (b) A lightening of physical work in moving scenery in and out,

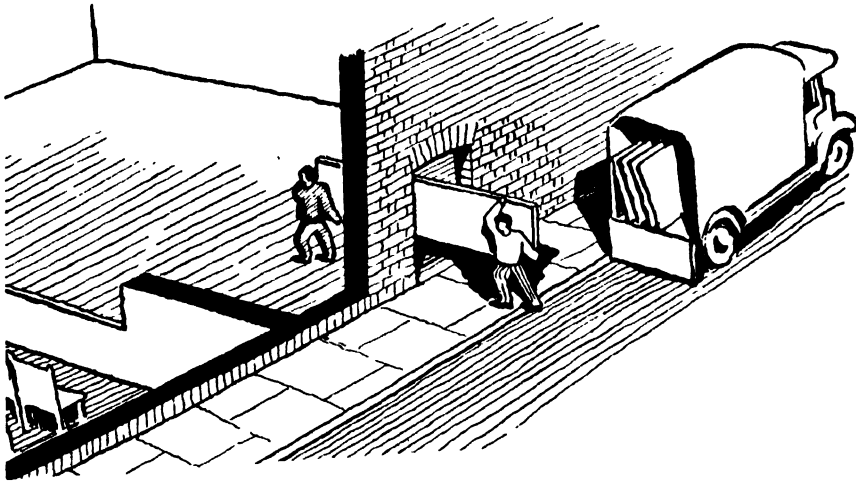

Fig. 17. The Advantage of a Stage at Street-level.

- (c) Consequent lessening of damage and wear to scenery from lifting, dropping or straining,

¹ The authors are indebted for the quotation to Miss Sybil Rosenfeld's manuscript on the History of Amateur Theatricals.

ESSENTIALS OF STAGE-PLANNING

(d) Even in a very small theatre, unaccustomed to importing scenery from without, the advantage of easier handling applies—if only to the getting-in of a hired sofa.

(e) A stage at ground level means a corresponding decrease in minimum roof-height, and sometimes the saving of a foot or two in the walls is valuable.

(f) Easier escape in case of fire.

The matter of the *height* of a stage—or, more accurately, of the depth below stage to which the floor of the hall is sunk—may be taken as a more or less fixed figure between 3 ft. and 3 ft. 6 ins., whatever the size of the theatre. In America, ‘modern theatre design normally raises the stage 3 ft. 4 ins. above the floor at row A, *i.e.* 6 to 10 ins. below eye level’ (quoted by John Cranford Adams, *The Globe Playhouse*, Harvard, 1943, p. 38).

In certain small theatres with very favourably raked floors, it may be possible to reduce this figure for stage height. For instance, the little Gate Theatre, Villiers Street, London (now out of action) had a stage only 1 ft. 6 ins. high. On the other hand, in present circumstances it is generally very undesirable to exceed 3 ft. 6 ins. Any supposition that a flat auditorium-floor may be compensated for by building a very high stage, up to 4 ft. 6 ins. and more, is ill-founded. The remoteness of the perched-up players is unsatisfactory, and the acuteness of the angle seriously tires the neck-muscles of nearer spectators. Too high a stage is possibly worse than too low.

(b) *Stage Rake*

Stage rake is a system of slightly sloping the stage floor upwards towards the back. The origin of the custom lay in the old use of perspective scenery, and it is solely concerned with the deception of a long-vista effect, increasing the apparent depth of the stage scene. In order to maintain a practicable working floor the rake had to be limited to about 1 in 24; it is thus of no value in improving the audience’s view of the players.

No form of stage rake is in any sense necessary or useful in a modern theatre. All stage floors should be flat.

(c) *Stage Shape*

The ideal shape is a plain rectangle.

If, however, the necessities of the site enforce an irregular angle upon one of the side or back walls, it is generally better to accept such an angle than to square the wall across and so reduce stage area, for any such space

THE STAGE FLOOR

surplus to the squaring may be used as room for packing scenery. All the same, it should be realized that such an oddly-angled wall may prove a constant limitation upon the planning of scenes.

Any angular encroachment whatever into the plain rectangle of the stage should be avoided. Switchboard platforms, hydrants and even radiators should very definitely be built in flush. An ideal stage has no projection whatever from the wall-surfaces (with the exception of the fly-floors above; see Chapter 7, Section (c)).

Concerning the actual measurements of the stage floor area, the following figures should be studied, and they should be understood as a deliberate revision of the Ensa measurements given on p. 9, which were only concerned with stages not intended to be involved in changes of scenery.

Minimum Width of Stage

The authors believe that the minimum overall width of any stage upon which a normal variety of plays may be presented in a style of reasonable efficiency is 32 ft. And it must be clearly understood that this figure applies to the total width of the stage floor from side wall to side wall; as will be described in Sections (g) and (h) of this chapter. The above 32 ft. is intended to provide for an 18-ft.-wide proscenium opening and two 7-ft.-wide wing-spaces, one on each side.

Minimum Depth of Stage

The authors believe that the minimum practical depth of a stage, calculated on the same basis as the above, is 18 ft. from curtain-line to back wall.

Concerning the maximum measurements for the same dimensions, it is less advisable to settle an actual figure, but in practice it is likely that, since the width of any stage is governed by that of its proscenium opening (being, as will be shown on p. 36, equal to twice that opening plus an extra 4 ft.), and since a comfortable opening in a medium-large theatre is probably limited to 36 ft., then the *maximum width* of a stage may be set round a figure of 76 ft. (that is, 36 ft. plus 36 ft. plus 4 ft.). *Maximum depth* is governed by the gallery sight-line, or line of vision from the uppermost seats in the gallery as controlled by the edge of the proscenium border. The figure probably rarely exceeds 60 ft.

A wider stage than that recommended above as maximum will suffer

ESSENTIALS OF STAGE-PLANNING

the disadvantage that scenery will have to be moved over such great distances from its place on the set to its packing-position against the side walls during scene-changes that time and energy will be lost. To reduce this distance by building posts or racks intermediately to serve for packs of scenery is practically the same as reducing the width of the stage.

(d) *Material of the Stage Floor*

A stage floor should never be of fancy woods, or polished. The dual-purpose stage in a school, which is parquet-covered for use as a hall platform, affords an unsuitable surface for the setting up of scenery. A stage floor should be capable of receiving screws with comparatively little damage to itself and should have a surface on which neither scenery nor performers are liable to slip.

Though a modern well-designed scene is capable of standing almost by itself, some form of brace is occasionally needed here and there to support the pieces. The foot of a supporting brace may be held in position in one of two ways; by weighting, or by screwing to the floor with specially-designed screws called *stage-screws*. (For illustrations of these technical terms, see Fig. 15.)

For the holding of a *french brace*, supporting a small ground-row, a single brace-weight may be sufficient. For larger pieces with french braces, however, and for all pieces with adjustable stage-braces it is quicker, less laborious, and quieter to use a stage-screw. If weights are used for the larger pieces, then two or three will be required in each case, and the moving and setting of these is cumbersome and noisy—though they have the one advantage of not damaging the floor of the stage. On the whole, though brace-weights are occasionally helpful, an intelligent and sparing use of stage-screws is probably the best method of fixing either variety of brace.

It follows then that the stage floor should be of a material to take screws. The softer woods are neither desirable from the point of view of wear nor—in certain localities—are they permitted by fire regulations. Teak and oak are recommended, though the former is expensive. Pitch pine is occasionally permissible.

The fact that stage-screws damage the floor in time is undeniable, but much can be done to lessen this damage by keeping the points of the stage-screws well sharpened, and by swabbing the floor boards once a week with water to assist the grain to take up again in the holes.

No stage floor should be of a material or design which prevents cuts

THE STAGE FLOOR

being made when and where necessary to provide for occasional openings.

At this point it may be said that it is often useful to cover the stage floor entirely with a first-quality linoleum. A poor-quality linoleum will stand little wear and is less useful than bare boards. Again, to cover only the central, or acting, area of the stage leaving the wing-spaces bare, is unsatisfactory, since the shifting of scenery over the edge of the lino will soon crack and tear the material.

Stage-screws may still be used with a good-quality lino and if, in the course of time, the material becomes much pitted, a square section may be cut away and a patch inserted.

Lino will easily take size paint which can also be washed off again when no longer needed.

The use of lino obviates the need for the usual stage-cloth, except when a particular effect is needed.

(e) Structure of the Stage Floor

The supporting joists of a stage floor always run traditionally across-stage, and the floor-boards up-and-down-stage. No other permanent up-and-down-stage member should be allowed in the stage structure when traps are likely to be used, for such a piece is liable to interfere with their working.

(f) Trapdoors in the Stage Floor

The question of the provision of apertures in the stage floor is a vexed one. Formerly they were considered essential. To-day, however, their use has almost entirely died out. Contemporary playwrights in general make no call upon traps whatever, and even the traditional pantomime is dropping all those features which depended on the use of traps. The following observations may, however, be made on the subject.

To begin with, a trap demands an accessible space under the stage with which it can communicate. Such a space should be at least deep enough to allow clear head-room for a standing person, and this will generally involve excavation. If the space is lacking, the whole question is closed. On the other hand, a stage basement is likely to be of considerable use as a receptacle for furniture and large properties, but in certain localities strict fire regulations forbid the use of a cellar as a store during the performance of a show, or restrict its use to such material as is required in the show itself. This means it cannot be used as a permanent store.

ESSENTIALS OF STAGE-PLANNING

It may be repeated here that the requirements of different local authorities in respect of theatre building and maintenance in their own area differ on matters of detail, and that it is of the first importance before planning a theatre to be fully acquainted with all the local regulations in force at that time.

With regard to other apertures in the stage floor, the old and the new points of view may perhaps be stated as follows:

The old conception was of what was called a *working stage*—that is to say, of a stage floor and substructure most elaborately designed so that almost any part of it could be pressed into service in the working of the show. Every section in the acting-area could be removed and use made of all variety of traps, rising bridges and sloat systems. But of the few traditional theatres in England which retain the old elaborate mechanism only a mere handful could restore the machinery to working condition and fewer still would have cause to use it even if it were restored.

We may or may not regret the passing of the old system. For those who care still to study it, perhaps with a view to adapting to modern use some of its technicalities, reference may be made to Edwin O. Sachs's *Modern Opera Houses and Theatres* (1896) and *Stage Construction* (1898). Some actual relics may be seen at the Theatres Royal at Bristol and Leicester and elsewhere.

Turning now to modern conditions: The varieties of aperture likely to be useful in the floor of a stage may be described under the following heads:

Dips. Dips are simply small hinged flaps in the floor boards by which access is gained to electric cables beneath, so that leads from occasional flood-lights, *et cetera*, may be plugged into their supply-points, thus avoiding a tangle of loose cables over the floor of the stage. Ideally, a row of dips should run along either side of the stage at 6-ft. intervals, and even in the smallest stages there should be at least two a side. Metal frames with a hinged flap may be obtained to let in at the position of each dip. Dips should be away from the walls of the stage so as to avoid being covered by scene-packs and should be just outside the limits of the acting-area. Dips are widely needed in modern lighting practice.

The Carpet Cut (see Fig. 18). A second variety of subsidiary opening in the stage floor is the long, narrow slot near the front of the stage into which the down-stage edge of the stage-cloth, or floor-covering, is dropped and trapped by the closing of a flap. The term is a misnomer, for a carpet proper is rarely held in a carpet cut.

The carpet cut should be situated immediately above the curtain line.

THE STAGE FLOOR

The cover of the cut may be in one piece and work with the help of a lever, or in the form of two, hinged flaps.

Other Openings. Beyond these two widely-accepted varieties of opening, the modern stage floor is frequently plain. Occasionally a squarish opening at the back of the stage may be used for the passage of furniture and large

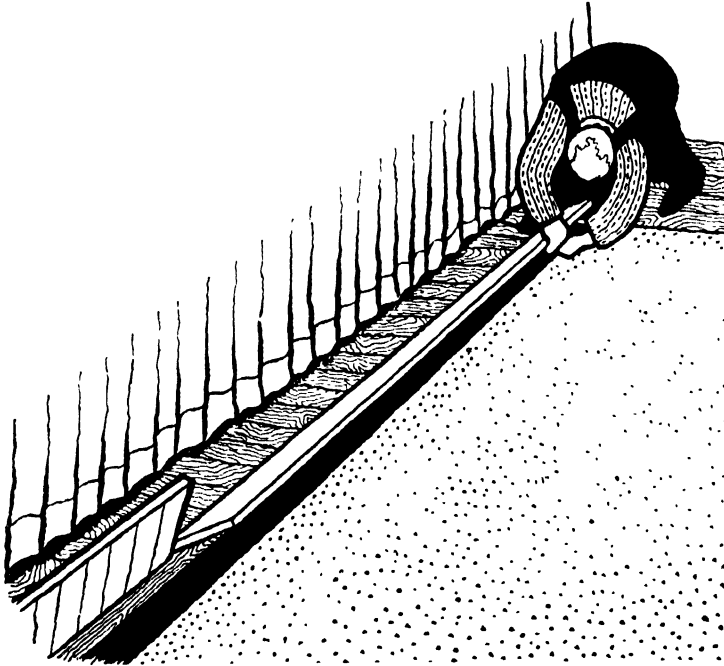

Fig. 18. A Stage-hand fitting the Edge of a Stage-cloth into a Carpet Cut.

properties to and from the basement, or a long, narrow opening for the passage of rolled-up backcloths.

Still more rarely does one see a survival of the old *grave trap*, an opening about 6 ft. 6 ins. by 2 ft. 9 ins., situated centrally across the stage and some 6 ft. back from the curtain-line. Its chief use is indicated in its name—to serve for the grave in *Hamlet*, and for such small 'pits'. Modern procedure is inclined to represent such cavities by building up a surround with rostrums, and engineering the hollow between them.

In those rare cases where a modern production calls for a trap, since no living tradition dictates its position on the stage, the playwright may suppose it anywhere, with the result that if a trap does exist it will probably be found in a totally different position from where it is needed.

Finally, it seems that in building a theatre to-day the best rule will be to

ESSENTIALS OF STAGE-PLANNING

provide a completely, or nearly, plain stage, but to design its structure in such a way that the resident stage-carpenter may cut a trap on occasion where needed, and close it up again himself when done with.

(g) Divisions of the Stage: (1) The Acting-area

To complete our review of the stage floor, we have now to consider certain aspects of its use during the actual presentation of a show.

In the first place it should be noted that the whole area of a stage floor is never used for the setting up, or performance, of a scene in a normal presentation. Scenery is set, or action takes place, only upon a limited part of the floor, which approximates to the centre portion of the stage and extends to that edge nearest the audience (see Fig. 19). This indefinitely-limited portion is called the *acting-area* and differs in shape according to the

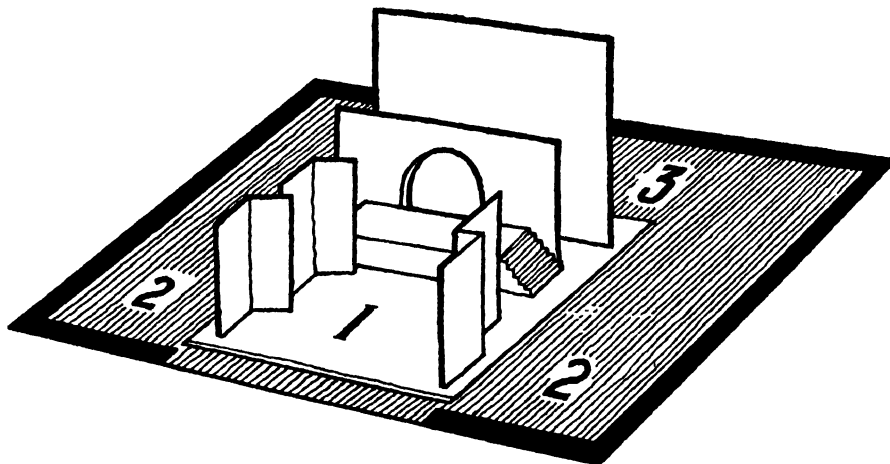

Fig. 19. The Divisions of the Stage: (1) acting-area; (2) wing spaces; (3) up-stage space.

show and the design of the scenery. But the essential point to notice is that at either side, and generally at the back, there must be further areas to allow for service of the scene within the acting-area. A stage with inadequate service-space is fundamentally an ill-designed stage. It is therefore of considerable importance to understand what these areas are and the services they are required to facilitate.

Concerning the central acting-area itself, the essential requirement is that it should be free. An ideal acting-area is an unobstructed space with a good, flat floor, and that is the nucleus of a stage design. However undesirable are obstructions in the surrounding service areas, to permit them in the

THE STAGE FLOOR

acting-area is unthinkable. There are no aids, accessories or other devices of whatever nature, save the free air itself, that are of positive and consistent value in the modern acting-area.

Formerly this was not the case, and many stages in past history have depended upon a more or less elaborate arrangement of accessories to the acting-area in the way of upper or inner stages, of various levels, of openings and of intercommunicating stairs. To-day, however, the 'formal' stage—that is, the stage whose *form* is designed to be contributory to the action of the show—is limited either to special occasions or to the special work of individual producers. The stage most likely to be of general use in modern conditions is the least 'formal' of all—the most personally negative and empty, thus offering the freest scope for the building of the most varied styles of scenery; any variations in level should be managed by means of rostrums and steps and should not be looked for as an integral part of the stage itself.

A study of the, often admirable, formal stages of contemporary experimenters might seem to lead to a different conclusion. There is no doubt, however, that in general use all such formal stages show, sometimes, very injurious discrepancies with certain styles of presentation. We must affirm that a good all-purpose stage should have no trimmings and should lay as little restriction as possible upon the choice of style.

It is equally true, on the other hand, that a good general stage suitable to the majority of to-day's requirements is often a serious handicap to presentations in certain formal styles or according to certain period-types. There seems no way out of this dilemma but to think of two separate varieties of stage design—one the 'normal', the other the 'experimental' in which very individual, and possibly quite unusual, features are combined into a sort of adaptable whole. This second type of stage the authors have decided to be outside their present province except in so far as certain limited specialities in the way of 'formal' detail may be mentioned later, which may be easily associated with a 'normal', unparticularized stage.

(h) *Divisions of the Stage: (2) The Wing-spaces*

Of the spaces for service outside the acting-area, the most important are the wing-spaces, that is to say the two strips of stage near the side walls, running from back to front, and cut off from the view of the audience.

Inadequate allowance for wing-space is one of the commonest faults on small stages—especially those built in dual-purpose halls—and thus the

ESSENTIALS OF STAGE-PLANNING

following observations on the functions of the wing-spaces and on the work that must take place in them are given in detail.

To begin with, every scene should properly have a clear run-round in which actors, singly, or occasionally in groups, can circulate with speed and quietness to gain their entrances. Not only is space required for access to a stage-entrance but it must be sufficient for players or groups of players to assemble reasonably in advance of their entrance-cue and make a few moments' preparation before they go on, or even do no more than wait for the moment of their cue, for it is no crime to be ready for a cue too early, though it is bad technique to be hurried, and unforgivable to be late. Entrances cannot be effective or well-timed if there is no elbow-room in the wings.

Secondly, wing-space is frequently needed for the preparation of scenery or furniture prior to a scene-change. It is valuable, for instance, to be able quietly to bring down items of furniture from the furniture packs (which are ideally in the back corners of a stage) to positions in the wings, some minutes before a scene-change is due, so as to be ready to take them immediately to their places as soon as the change begins.

Thirdly, there may be essential effects which can be controlled and worked nowhere so efficiently as in the wing-spaces. (For instance, in a production of *Journey's End*, at least five effects-men were needed with their impedimenta of drums and crash-machines all immediately and equally available to the direct signals of the stage-manager in the wing-space.) Again, the getting-in-place of the members of a procession, of a massed entrance, or of a set dance requires space for manoeuvre.

Opportunity is frequently needed for the setting-up of side spotlights or floodlights or of auxiliary switch boards. Space must also be available for backings and for the players to move round these backings to gain access to their entrances.

And, finally, what may often be the heaviest demand of all upon wing-space has to be met—the need for room in which to make *dead* and *live* packs of scenery (see Fig. 20). It is desirable generally that all the pieces of scenery used in one play should be kept on the stage throughout the performance. They should not have to be removed to, or brought out from, a separate dock or store once the curtain is up; everything should be immediately to hand in its appointed place. The only spaces available are the wing-spaces, the flying-space above and, to a lesser extent, the back space. The flies, however adequate, cannot take everything, and if they are inadequate

THE STAGE FLOOR

can take nothing at all effectively, and so it is that most scene packing is done in the wings.

A 'pack' of scenery is a pile of pieces leaning together against the wall or some special support. The pack is made up in a very carefully pre-arranged order so that the pieces are available in just the succession which allows

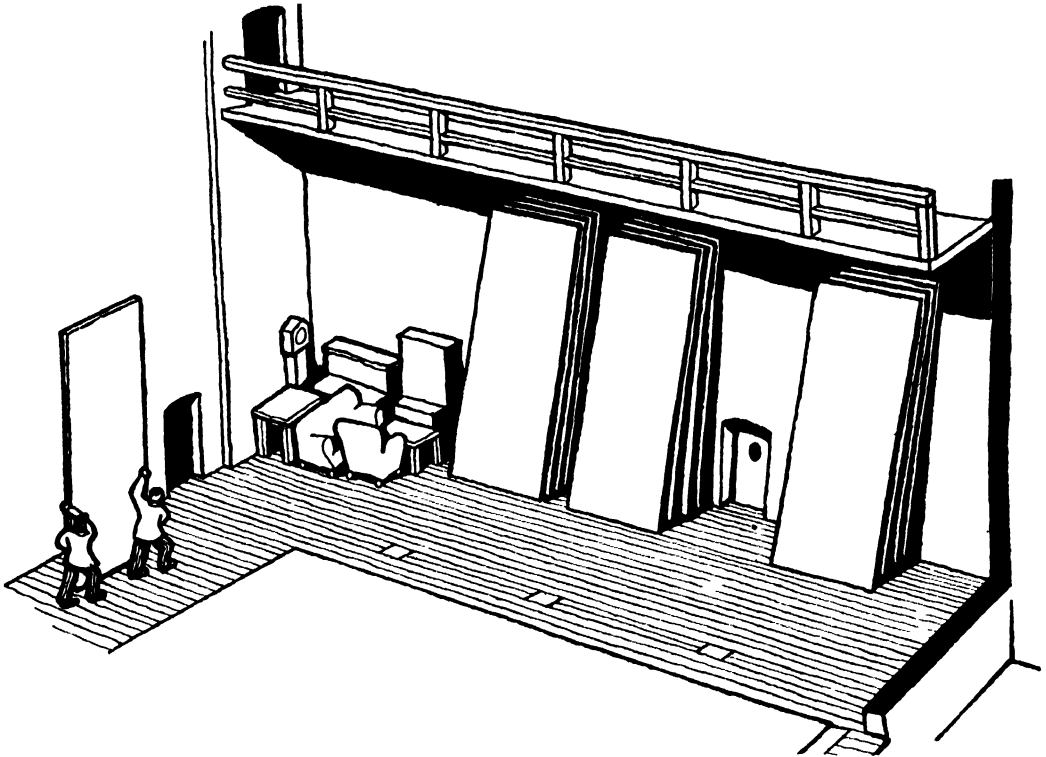

Fig. 20. The Three Packs of Scenery in the Wings.

them to be set most speedily. A *live* pack contains material wanted for coming scenes; a *dead* pack is an entirely distinct pack for pieces as they come off the scene finished with, or 'dead', for the rest of the performance. Occasionally a third pack is made of pieces which have been used in a previous scene, but which must be 'kept alive' for use again in a succeeding scene.

Thus, on any stage, six packs of scenery may be needed, three at either side. These must be accommodated easily and without prejudice to all the other functions of wing-space outlined above.

It will thus be readily understood that the authors have no hesitation in demanding as a *minimum* figure, the clear working space of 7 ft. of wings either side on even the smallest properly designed stages. The commonly-found allowance of 1 ft. 6 ins. or less in some types of hall is totally

ESSENTIALS OF STAGE-PLANNING

inadequate for serious work. Ideally, each wing-space should equal half the proscenium opening plus 2 ft. This figure is based on the desirability of being able to move two 'boat-trucks' (each measuring half the width of the proscenium opening and occupying together the full acting-area) off into the wing-space and still leaving a 2-ft. passage for circulation around them.

(i) *Divisions of the Stage: (3) The Up-stage Space*

The up-stage space is at the back of the stage between the back of the set and the wall of the stage.

Properly such space should always be available, even with the deepest scene, to allow players and stage-hands access from side to side of the stage. In addition to such cross-passage the upper back corners of a stage are generally the most practical places to dispose furniture-packs. The central part of the back wall is frequently the only position in which empty boat-trucks can be upreared for packing. Ideally, flats should not be packed on the back wall—even those from the back of the set; these latter should generally be battened-out and flown.¹

In many small theatres it is found (and this is a matter for criticism) that the only adequate space for the normal day-work of the stage-carpenter is upon the stage itself. In such a case he will, on a shallow stage, be faced with the task of taking down all or part of the current set on the stage before he can begin work. This is a waste of time and consequently of money. The deeper the stage, within reason, the more likely is the carpenter to find adequate room for his work during the day in that space behind the scene.

(j) *Divisions of the Stage: (4) The Forestage*

In the current, normal procedure of the professional stage a forestage is very rarely used. One bar to its use (see Fig. 21) is that many medium and larger theatres are so designed that the line of vision from the majority of the gallery seats before it reaches anything much lower, or nearer, than the foot of the proscenium curtain is cut off by the spectators in front or by the gallery-front itself. Thus a player advancing beyond the curtain line becomes progressively cut off from the feet upwards. Again with regard to the stalls, an extension of the stage forward either involves uncomfortable upward-craning of the neck in the front rows—or the removal of two or three of those highly-paying front rows altogether.

¹ For considerations on the subject of the cyclorama see Chapter 5, Sections (b) and (c).

THE STAGE FLOOR

But in a specially designed theatre, these disadvantages need not occur, and the question then arises: Given a properly disposed forestage, is it likely to be of value in modern production?

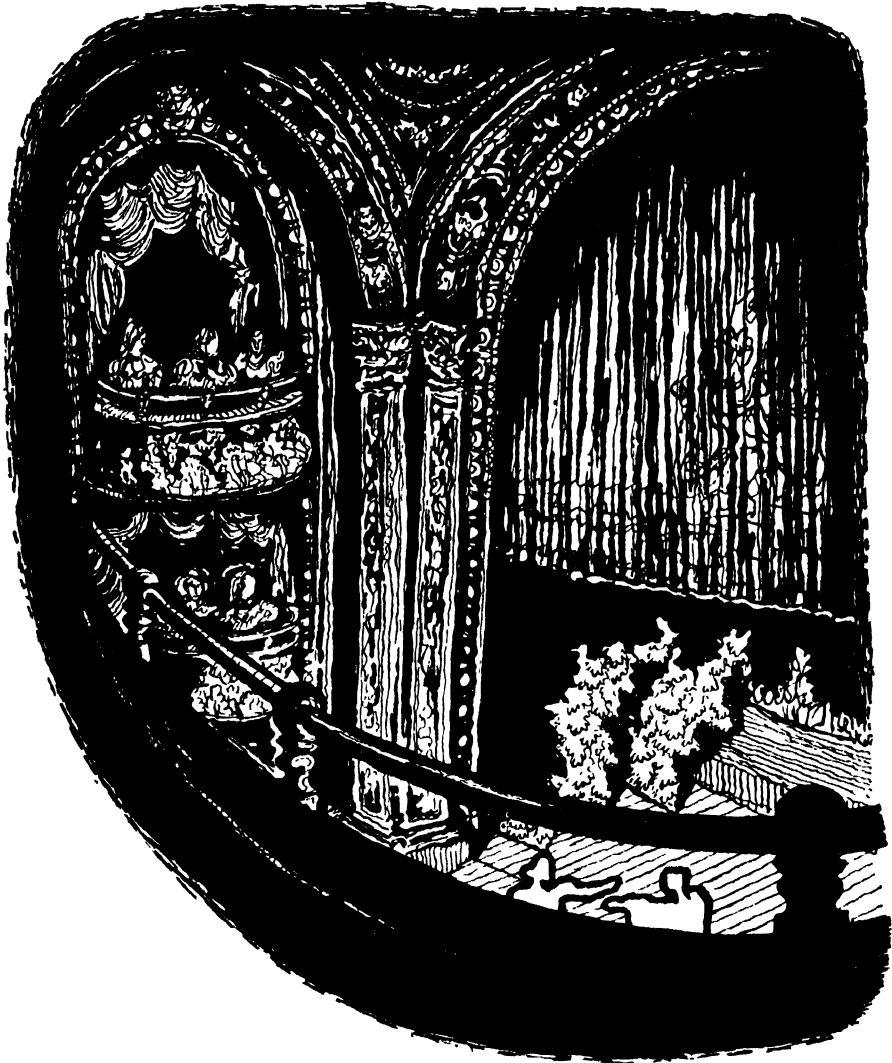

Fig. 21. Illustrating the unsuitability of certain Theatres for Forestage Work (see p. 36).

The question is not capable of a direct, general answer without some examination.

A forestage is a forward-extension of the stage in front of the curtain line. It is to be understood here as implying an extension of some size (that is, from 2 ft. to 15 ft. deep) capable of being used by actors for the playing of

ESSENTIALS OF STAGE-PLANNING

front scenes. Such a forestage generally involves the use of a deep proscenium-side containing a door, left and right, for access to the forestage.

A type of forestage frequently seen in small halls and experimental theatres is given in Fig. 22, but the principles behind its use to-day are somewhat confused. It is reckoned to be a help in, for instance, Elizabethan

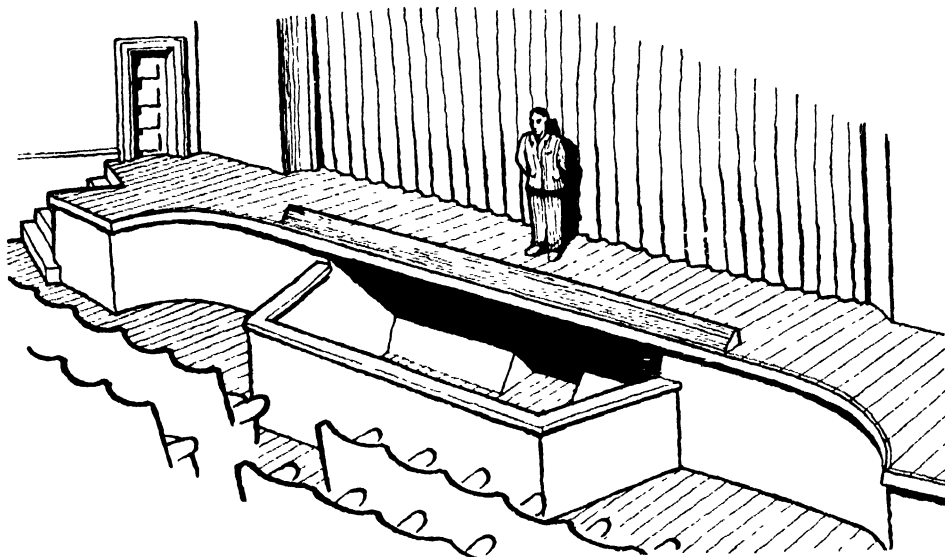

Fig. 22. A Typical Little-theatre Forestage.

plays when the short, almost unlocalized, intermediate scenes can be played on it, leaving the main stage free behind for the setting of the ensuing full scene (though this is, of course, only an approximation to actual Elizabethan technique). It is also commonly used for individual 'turns' in variety. But beyond this its use—except in the hands of certain individual producers—is rare.

Should, then, a forestage be provided in a new theatre?

In the first place, a forestage is not called for in the normal range of modern drama. It may be occasionally useful in individual instances of unusual play-forms. Whether future developments in drama will revive its use or not is unpredictable. Its value, however, in revivals of certain period plays is considerable. No theatre whose programme is to include Elizabethan, Restoration or Georgian work can afford to ignore the forestage unless it is decided to present the plays without regard to their contemporary production-style. It is, moreover, increasingly felt that a period play may gain very considerably in freshness and in interest if presented in the stage conditions which it was written to fit. There is a movement—

THE STAGE FLOOR

especially in theatre-training centres—for closer and closer research into period conditions—not so as to attempt a lifeless imitation of a past art, but in order to inform the style of the modern production with certain conventions without which many details of the play become obscure or wholly meaningless. There can be no doubt that development in such a direction is valuable, and that the inclusion of a forestage *in certain types of theatre* is not only desirable, but in the end inevitable.

There are, however, three types of forestage:

Firstly, the effect of a forestage may be partially obtained by pushing the scenery back from the proscenium (see Figs. 23 and 24) and inserting a couple of door-flats either side in the gap. But this is only a compromise. A 'forestage' behind the proscenium, however ingeniously the stage-sides are faked, is a very different thing in its effect from a forestage in front of the proscenium. There is one instance, however, where such an arrangement as the above can be applied with excellent effect—and that is upon what is described on p. 77 as the 'proscenium-less' stage. Here the arrangement gives the closest approximation to the traditional forestage as it was related both to the main stage and to the auditorium (see Figs. 25 and 26).

Secondly, a forestage may be introduced by providing a temporary flooring over the orchestra-well, or by the building of a row of rostrums on the floor in front of the stage. Again the effect is a compromise and can rarely be that of a genuine forestage. In many theatres the effect will be that shown in Fig. 21.

Thirdly, the genuine forestage, incorporated as part of the original design of the building, needs especial study and a close knowledge of the styles of production likely to be used with it. A period forestage is often remarkably deep—for example, that in Christopher Wren's Drury Lane of 1674 measured 21 ft. from front edge to curtain line, though the theatre was only about the size of the present Theatre Royal, Bristol. But the whole of

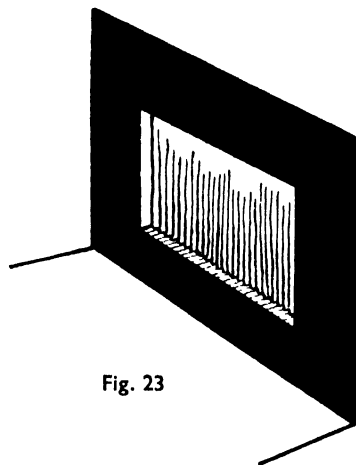

Fig. 23

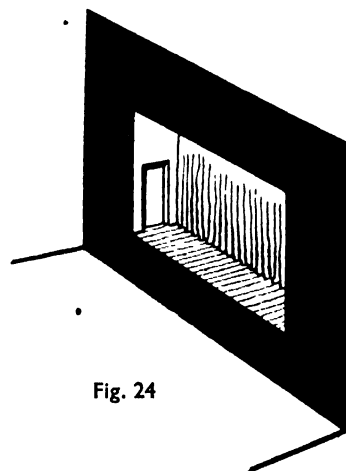

Fig. 24

Figs. 23, 24. Illustrating a Substitute Forestage provided by pushing the Tabs upstage and inserting Door-pieces.

ESSENTIALS OF STAGE-PLANNING

the effect, in its own period, of this forestage was that it was built between the walls of the auditorium itself, so that the side boxes and galleries were actually on this forestage and looked over it from side to side.

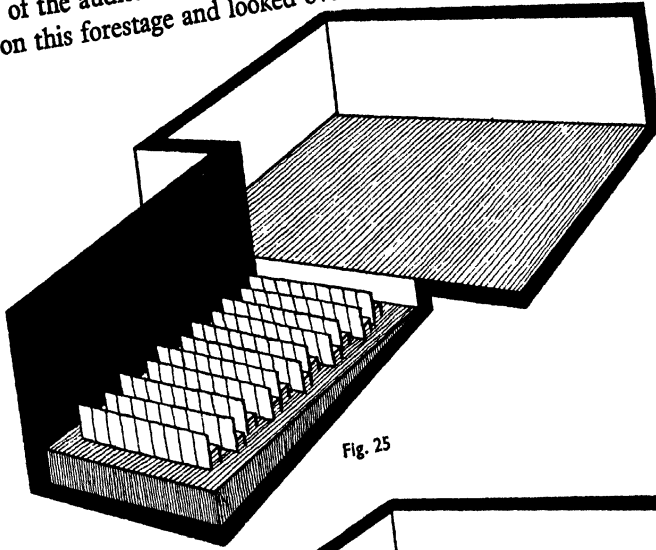

Fig. 25

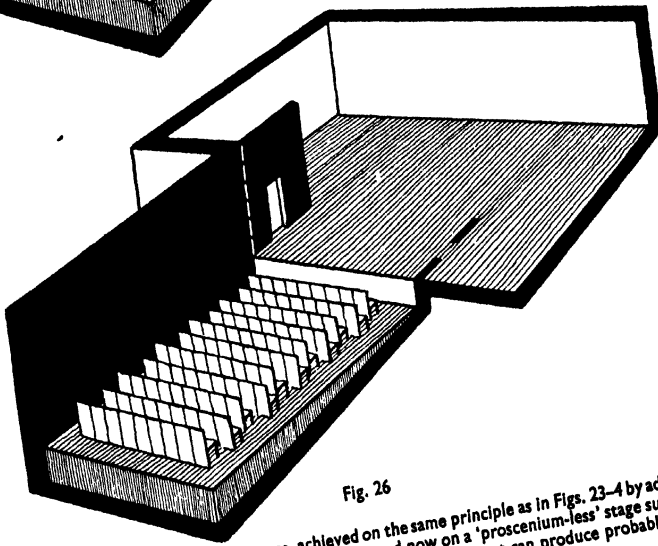

Fig. 26

Figs. 25, 26. A Genuine Forestage, achieved on the same principle as in Figs. 23-4 by adding side door-pieces to the stage, but employed now on a 'proscenium-less' stage such as is described on p. 77 and in Fig. 53. Such an arrangement can produce probably the soundest and most useful form of forestage.

In such an arrangement, the majority of the playing took place on the forestage. The forestage was in fact the acting-area. The scenic area at the

THE STAGE FLOOR

back was relatively only decorative and was but rarely used by the players at this period—it was primarily for show.

Thus, to plan a genuine Restoration forestage in a modern theatre would manifestly mean a completely new arrangement for the auditorium,



Fig. 27. The Cut-down, Late Georgian Forestage, as exemplified at the Theatre Royal, Bristol.

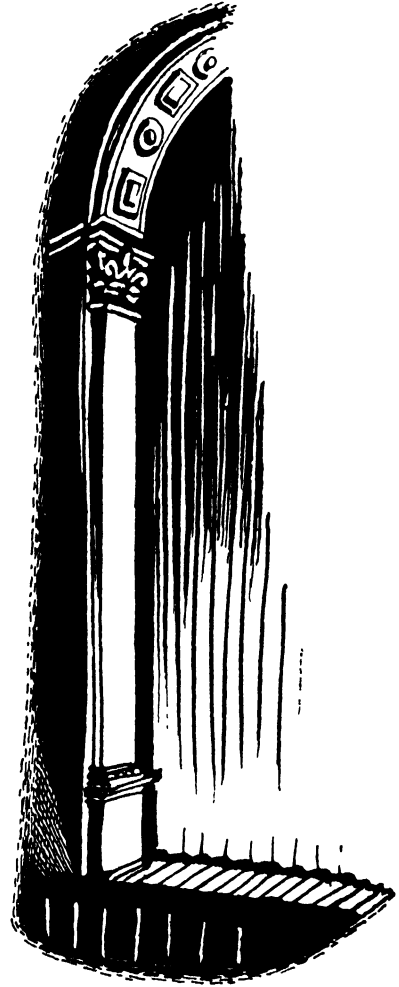

Fig. 28. The Vestigial Remnant of Forestage in a Typical Theatre To-day.

and a stage upon which every modern-style production would be like a fish out of water on the bank of its own pond.

It seems, then, that the wisest answer to the problem posed above is threefold:

ESSENTIALS OF STAGE-PLANNING

For public theatres, only intending to stage normal-style contemporary productions (or historical plays adapted to the normal style), a forestage is of no use at all.

For experimental theatres, for theatres specializing in drama of all periods and (therefore) for school theatres, and for small theatres of wide policy where 'variety' may be housed as well as straight drama, a small forestage—about 5 ft. deep—is desirable, and this may be made removable.

For genuine research theatres, specializing in the study of period production-styles, not only is a forestage necessary, but it must be capable of extension to something pretty deep, and it will involve a special design of the auditorium to suit.

(k) Concerning Revolves

A revolving circular section in the stage floor is not the magic solution of all scene-changing, nor is it an infallible sign of a well-equipped stage. Nevertheless, it is a device which clearly needs some consideration here.

Generally speaking, there are two types of revolve:

First, the small type intended to turn a comparatively small setpiece on centre-stage, either slowly during the progress of a scene, or at greater speed with the curtain down between scenes, but mainly for the purpose of a visual effect. Such a revolve is a straightforward matter, but is very rarely called for by playwrights.

The second type of revolve is intended to contribute much more considerably to the problems of scene-changing, and to be capable of turning a complete set out of sight and replacing it by another, it is this latter type of revolve which is generally in mind when the term is used. But it must be realized that it is quite impracticable on any stage whose total area is not at least four times the size of its acting area—and such a stage cannot be called a small stage.

The accompanying diagrams (Figs. 29–32) show a typical small stage with a set in position (Fig. 29). Superimposed on the diagram is a circle of the smallest size capable of taking the set and at the same time a second set of similar size behind the first to replace it on the turn of the revolve. The increased size of stage required to accommodate such a revolve is shown in the next diagram (Fig. 30).

This second diagram also illustrates another point; a revolve, even of this size is still unable to take the down-stage ends of the set sides. But to increase the diameter of the revolve so as to accommodate these ends will

THE STAGE FLOOR

necessitate a section of the revolve projecting through the front curtain—which is not permissible, since, during the turn, part of the scenery will, of course, foul the curtain. With such a revolve, the only possible curtain is one on a curving railway, bent out to correspond with the edge of the revolve (see the dotted line in Fig. 31).

This problem of the down-stage ends of the sides may be solved without

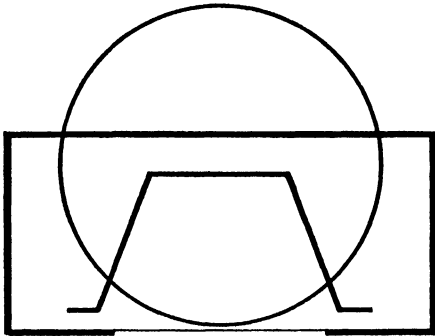

Fig. 29

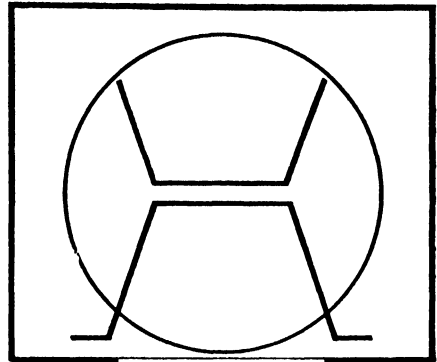

Fig. 30

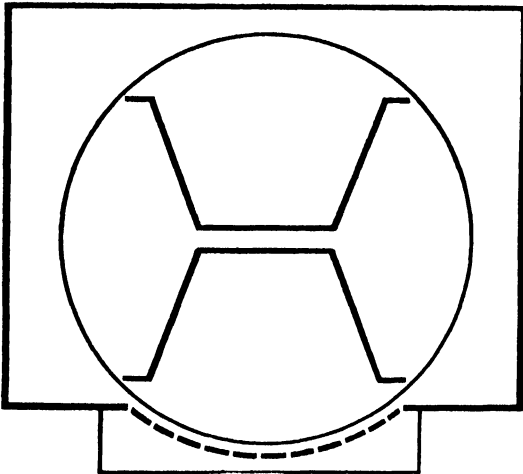

Fig. 31

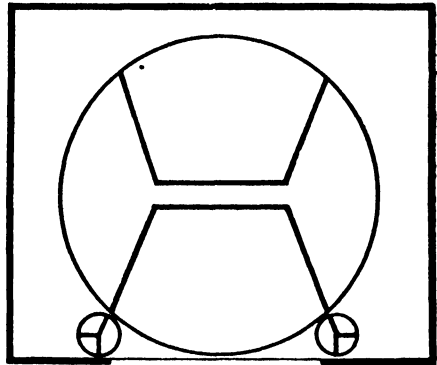

Fig. 32

Figs. 29, 30, 31, 32. Illustrating how an effective revolve can only be added to a stage of some size, and how a single revolve can never contain the front-corner elements of a normal set without projecting in front of the curtain-line.

increasing the size of the revolve, by adding two smaller revolves either side as shown in Fig. 32. These small revolves carry the extremities of all sets built on the main revolve, similarly arranged back to back, and they will turn in concert with it. Even in this arrangement certain additional elements may be necessary to mask the inevitable gap between scenes and proscenium.

ESSENTIALS OF STAGE-PLANNING

The assistance a revolve offers to normal types of set is therefore strictly qualified and involves certain special adaptation of the design of the sets.

If the normal type of set is abandoned and a new system introduced especially to suit the action of the revolve, only then can the revolve show its reputed advantages to the full. Such innovations, however, may not suit the general scenic policy of a theatre.

Certainly the revolve is a good solution of many scene-changing problems when used on a large stage and for a spectacular type of production. In medium-sized theatres using the normal traditional setting-styles of box set or wing-and-cloth scene, the revolve is a mixed blessing, often leaving nearly as much work to be done as before.

CHAPTER FOUR

THE 'ROOF' OVER THE STAGE

WE turn now from the floor to considerations governing what might be called the 'top of the cage', or the upper surface of the stage cube.

Over all normal stages of professional character preparation must be made for means whereby to hang scenery and lighting equipment, and generally not only to hang it but to *fly* it, that is to say to pull up the hanging pieces out of sight of the audience when not needed in the scene. In small theatres this may present difficulties which can only be solved, or rather circumvented, by the adoption of alternative methods as described in Section (*d*) of the present chapter.

(*a*) *On Hanging and Flying Scenery*

It is possible to go a considerable way with other methods of supporting scenery than flying—for instance, curtain-sets may be hung from a standing fit-up supported by legs from the stage, and even roller-backcloths may be worked on a 'gallows'—yet no normal stage can be said to be adequately equipped without means for hanging from above, and in most stages it is absolutely essential.

What is, however, far less generally recognized is that not only is *hanging* essential but it is of equal value to be able to *fly* the stuff that is hung. In many instances, *flying* is the quickest and the cheapest method of shifting scenery; for instance, to strike the back wall of a box set with reasonable speed may require four skilled men—or six, or even eight, unskilled—whereas if all the flats in the back wall are battened-out into one solid piece, the whole may be counterweighted and flown in a fraction of the time by two men only. In practice, it might almost be said that a theatre should fly—

- (*a*) all borders,
- (*b*) all backcloths,
- (*c*) all curtains,

ESSENTIALS OF STAGE-PLANNING

- (d) most flat back-walls entire, and
- (e) all lighting battens, spot-bars and flood-bars.

and careful calculations must be made to provide for the support for all these.

(b) *The Grid and Its Lines*

In normal professional theatre procedure, scenery is hung by means of lines from the *grid*—a grid being in principle simply a specially-constructed floor high above the whole of the stage area (see Figs. 58 and 59). This floor is specially constructed, both as regards its joists (which are designed to take very considerable weights over a more or less large span) and as regards the ‘floor-boards’—which are narrow and not laid close together, but with intervals between sufficient to take the passage of the lines; thus the floor is an open grating, whence comes its name. The joists (as opposed to those of the stage floor below) must run up-and-down stage, that is from back to front, and the ‘floor-boards’ must run from side to side. In this way the positions of pulley-blocks may be more easily adjusted.

The design of the grid in any theatre is generally a matter upon which expert advice should be sought before the stage plans are completed and certainly before the stage walls are built. The grid and the flying system in a modern theatre form one department to-day in which specialized machinery is widely used on a considerable scale, and this machinery should be of the best design. An ill-designed grid system may be astonishingly more costly of labour to work than a well-designed one, and the use of inefficient pulleys of the wrong dimension may result in a constant extra expense in the number of flymen. This is true even of the simple hand-worked system; for a counterweight system expert advice is even more important because of the extra weight and in order to ensure proper consideration of certain less obvious matters—such, for instance, as the points of high lateral strain which are as significant as those of vertical strain. Such matters should always receive the attention of a competent specialist firm (such as the Hall Manufacturing and Supply Co.) early in the preparation of a scheme.

The function of this grid is to permit pulley-blocks to be fixed upon it, singly or in ‘sets’, over which the lines run, passing through the intervals in the floor and down to support the scenery below.

The line system (see Fig. 33) is one by which three lines (in large theatres five) are dropped, one at the centre and one each towards the left

THE 'ROOF' OVER THE STAGE

and right of the stage. To the ends of the lines in such a 'set', the top batten of a border or a backcloth is attached. The lines ascend to the grid, and they are there turned over pulleys and led together towards one or the other side wall of the stage. The group is there led over a multiple pulley-block and brought downwards again through the grid either to the floor of the stage or, more usually, to the rail of a gallery (the fly-floor) specially built in the side wall to accommodate the great lengths of free end of rope and prevent their cumbering the wings. Here the set of lines is made off together round a cleat.

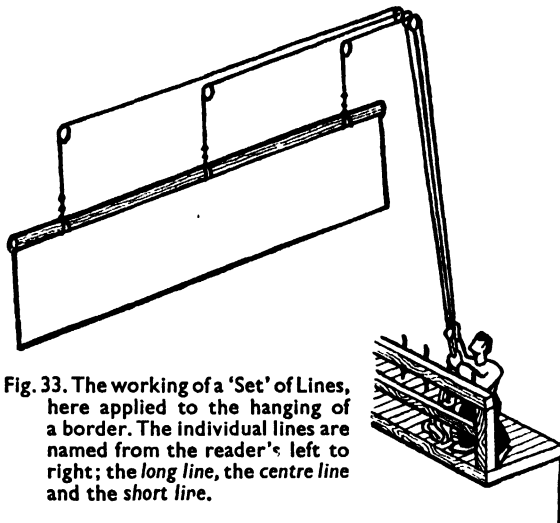

Fig. 33. The working of a 'Set' of Lines, here applied to the hanging of a border. The individual lines are named from the reader's left to right; the long line, the centre line and the short line.

(c) *The Height of the Grid*

The immediate question concerning the grid for anyone planning a stage is what is its most practical height?

To be effective, a grid must be what may appear to some unexpectedly high—and this for very clear and specific reasons.

To begin with, the tightest, minimum, effective height for any grid is three times the height of the highest point on the edge of the proscenium border.

We must be clear about this measurement; the distance referred to is *not* the height of the proscenium arch (which, as we shall see in Chapter 6, Section (f), is possibly completely unrelated with the scale of anything on the stage), but is instead the height from the stage floor to the highest point on the edge of the proscenium border—the *highest point* being stressed because a proscenium border may be deeply scalloped or cut to a shape.

It may now be objected that the proscenium border is itself capable of being raised and lowered. In this case, however, we are supposing it to be set at the normal height at which it is used with a scene of normal standard size in the particular theatre under consideration.

The height of an *effective* proscenium opening is very commonly over-estimated; it may vary in different theatres between 10 ft. and 16 ft. Only in special cases, even in large theatres, does it ever rise above 16 ft.

Let us, as an example of the reason for our calculation of grid height,

ESSENTIALS OF STAGE-PLANNING

take an effective proscenium opening of 12 ft. high. The tightest minimum for the grid height will now be $12 \times 3 = 36$ ft. Let us see why this is so:

(a) The scenery behind any proscenium must be higher than the proscenium opening in order to mask at the top. This excess is around the figure of 2 ft. to 6 ft. With a 12 ft. opening you will need to use backcloths at least 14 ft. (and, better, 16 ft.) high.

(b) To fly a cloth effectively it must be lifted above the stage for a distance somewhat *more* than its own height, otherwise its bottom batten will hang perilously near the tops of the scenery below and may cause fouling. Especially must a considerable interval exist between the bottoms of flown stuff and the tops of set stuff when a ceiling is used over a box set, for the lines of the ceiling will need manipulating. This interval should be at the very least 3 ft., and more is very valuable as will be shown.

(c) No cloth can in practice be flown right up to the grid—it may, by inexperienced flymen, be pulled up slightly askew; the lines may not be tied to the cloth-batten in a dead-exact vertical line beneath their respective grid-blocks; the knot itself (or, rather, the two half-hitches with which it is customary to secure the end of each line round its standing part after the clove-hitch proper is made) takes appreciable room, and in point of fact the very minimum figure allowable for what may be termed ‘grid-tolerance’ is 1 ft.

Thus for a 12 ft.-high opening, we have to use 16 ft. cloths which require, in order to fly, a space twice their height (that is $16 \times 2 = 32$ ft.) plus 3 ft. clearance above standing stuff ($32 + 3 = 35$ ft.) plus at least 1 ft. grid-tolerance—total, 36 ft., or three times the height of the opening.

But this is not our final consideration.

It will be noticed that in no single item above has any margin of error been allowed; each figure is calculated to a minimum. Grid-tolerance may in fact be 2 ft. or more; clearance may need to be vastly more—and it will greatly simplify stage lighting if it is at least 10 ft. Lastly, it may on occasion be required to fly a taller cloth. All of which points to one thing: in spite of our specified method for calculating a *minimum* figure for grid height, in point of practice a stage really needs for comfort a grid *four times* higher than the effective height of its proscenium border! A normal, full-sized stage can rarely do with less than a 60 ft. grid.

(d) *A Grid Substitute for Small Stages*

First let it be understood that no theatre which sets out to serve the requirements of normal professional stage procedure can in the authors’

THE 'ROOF' OVER THE STAGE

opinion afford to dispense with a grid of at least the minimum height indicated by the above calculation. But this will face the designers of small stages with an almost insurmountable difficulty.

To provide for, say, a 60 ft. grid means the building of a tower approaching 70 ft. high (for some space must be allowed above the grid for

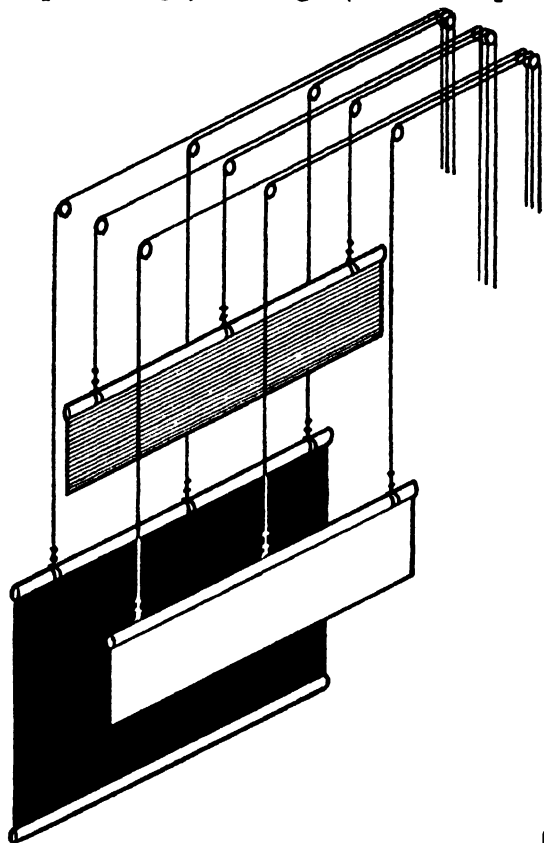

Fig. 34. The Flying of Borders (a). Here the unshaded border is shown in position with a back-cloth. The shaded border is represented as 'flown' or out of sight, and ready to be substituted for the first border in a scene-change.

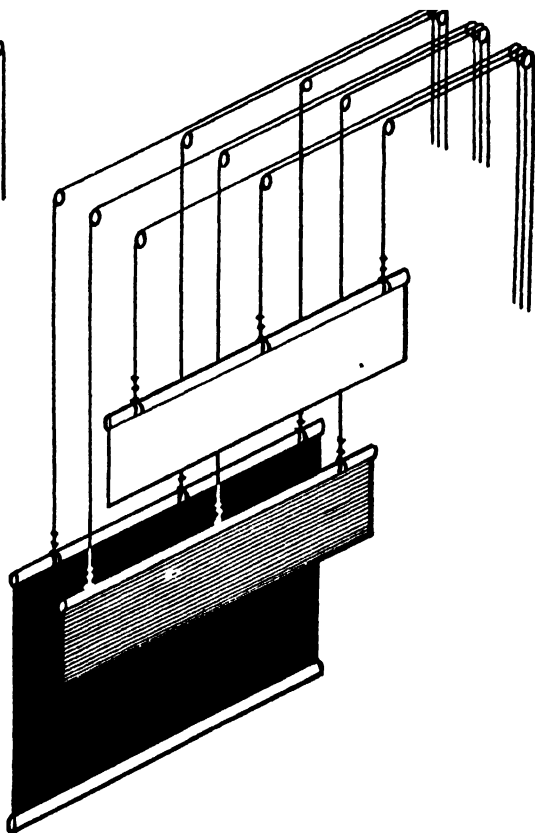

Fig. 35. The Flying of Borders (b). Here the change of borders is effected and the shaded border is shown in position with the back-cloth, while the unshaded border is 'flown' and out of sight.

access). Not only is this costly, but local conditions may forbid it for other reasons. What then may be done?

We may say at once that much valuable though limited work can be done upon a stage which renounces the principle of full flying altogether, and uses instead a working headroom for hanging borders and lighting equipment, at the same time arranging to strike all flat back-walls to the sides. Of necessity, too, the principle of *rolling* must be adopted for all cloths; and the use of 'framed cloths' excluded.

ESSENTIALS OF STAGE-PLANNING

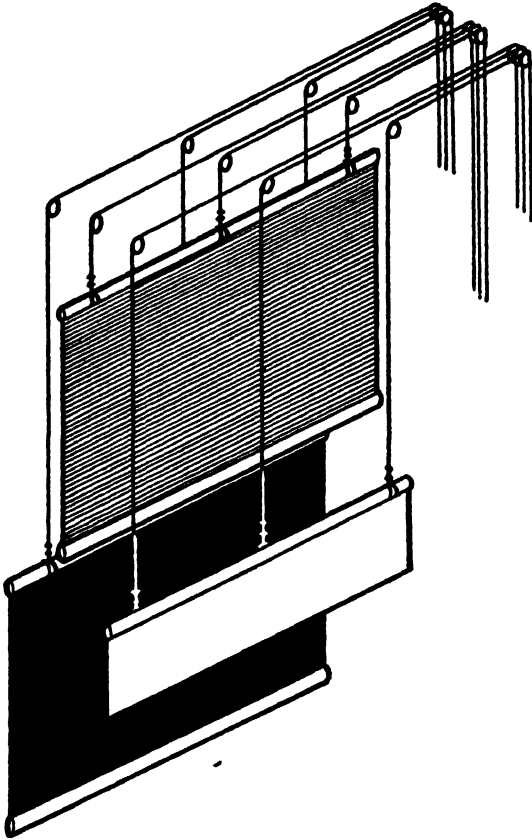

Fig. 36. The Flying of Back-cloths (a). Here the dark back-cloth is shown in position with a border; above in the flies, a second, shaded, back-cloth is ready to be lowered in the scene-change.

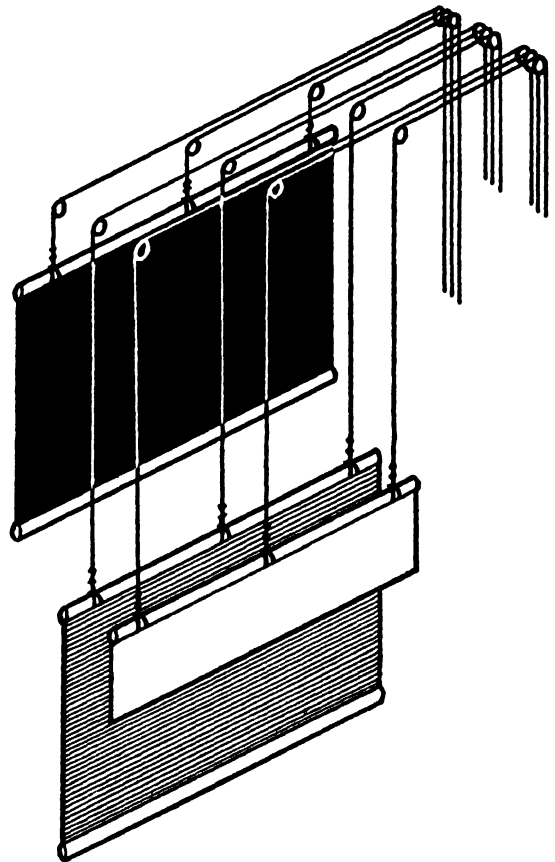

Fig. 37. The Flying of Back-cloths (b). The dark back-cloth is now 'flown' for the change of scene and the shaded back-cloth is lowered in to position. If necessary, the border would be similarly changed. Such a system of flying full backcloths is only possible on a stage possessing special headroom or 'flying space'.

The arrangement to be visualized now (see Fig. 39) is one where, above a normal small stage, a normal, solid ceiling is built. Below this ceiling—just sufficiently far away to allow fixtures to be made around them—are five joists or bearer-beams spanning the stage from back to front. These bearers are firmly housed in the walls and are designed to offer supports for sets of pulleys in the same way as a grid. They are arranged one over the centre-line of the stage, one either side close to the side walls, and the other two either side the centre bearer at a proper distance to avoid sag in any part of the border, or other, battens to be suspended. A wide stage intended to receive scenery of varying widths from touring companies may be well advised to use seven of these bearers, duplicating the last

THE 'ROOF' OVER THE STAGE

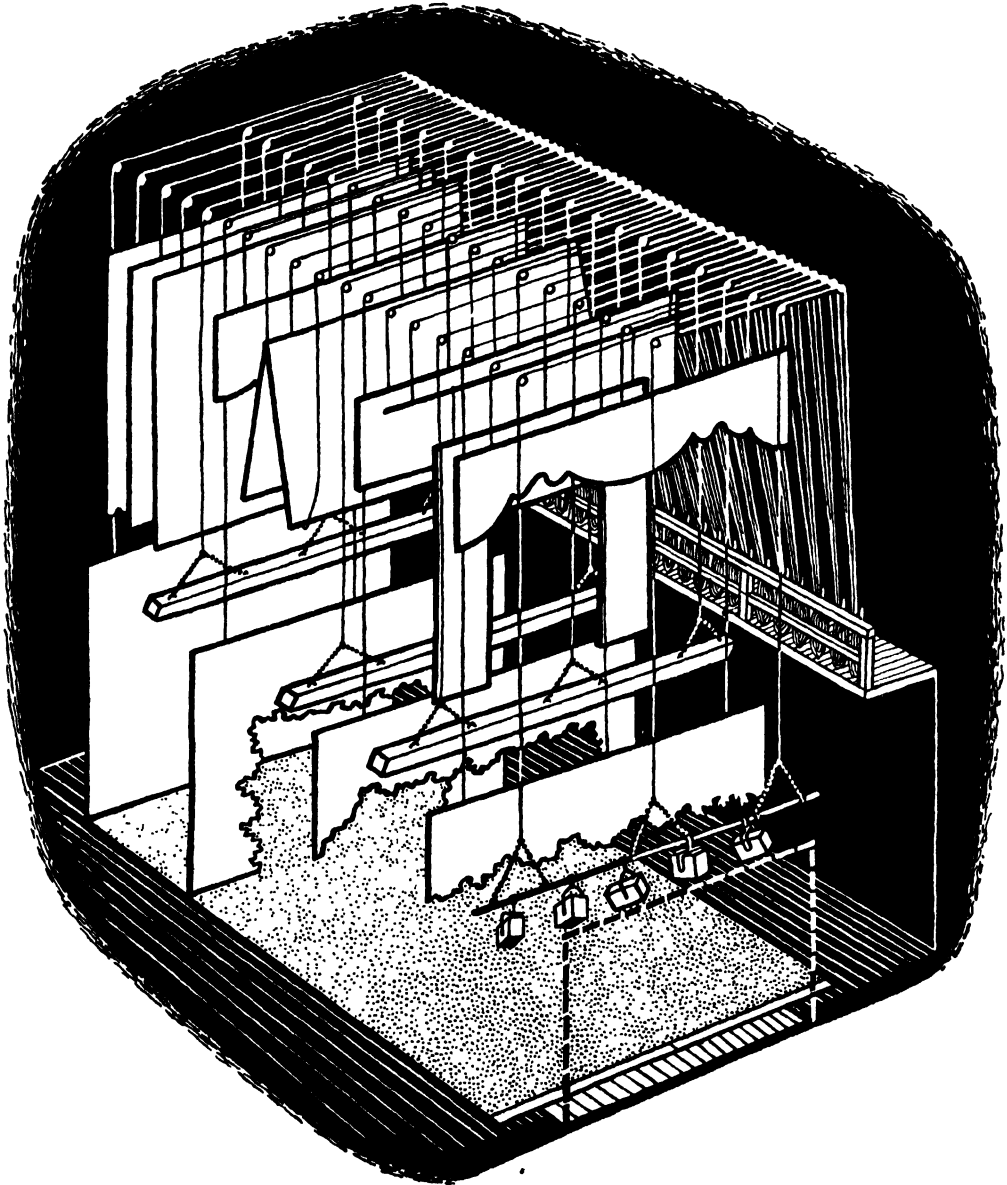

Fig. 38. The Development of the Complete Flying System. The principle shown in Figs. 33-7 is here developed to handle the scenery, *et cetera*, of a medium-sized, fully-equipped stage; showing the complication necessary to handle cloths, borders, ceilings, light-battens, leg-drops, *et cetera*.

ESSENTIALS OF STAGE-PLANNING

pair so as to be able easily to take lines from different lengths of batten.

The centre bearer is now fitted with a row of pulleys to take the centre lines of all hanging pieces. (Many types of grid block are available from stage suppliers for screwing into, resting upon, clipping round, or gripping, a

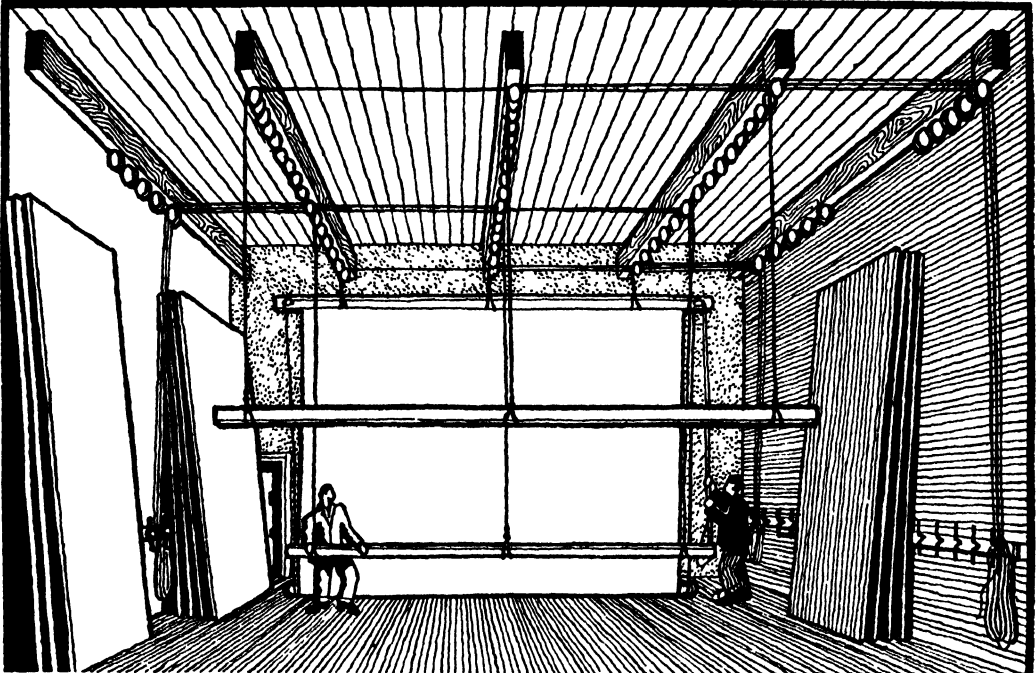

Fig. 39. A 'Grid-substitute' for use on stages without flying space.

great variety of types of bearer.) The intermediate bearers are similarly equipped to take the long or short lines; and upon the outermost bearer, triple head-blocks are fixed to take the sets of lines down to the stage. Of course, only one head-block is needed for each set of lines, and therefore the whole system can be worked in theory from one side of the stage, thus obviating the need for the opposite outermost bearer; but in practice, upon a stage of this nature, the object is to avoid covering one side wall completely with descending lines, by taking part of them down one side of the stage and part down the other, thus leaving some clear wall-spaces for packing on either side. In deciding the thickness, or sectional size, of such bearers, whether of timber or of steel, the advice of the architect should be sought.

The system is, then, rigged with lines in the usual way and provision is

THE 'ROOF' OVER THE STAGE

made for tying-off upon rows of cleats along the sides of the stage. It may be noted that the useful working headroom above, upon which to base the height of a ceiling over a fly-less stage, is a clear 7 ft. in excess of the effective height of the proscenium opening.

The question now arises: Supposing the designer of a new stage is unable to provide for a grid of the minimum height earlier recommended, but is still able to build his roof to a substantially greater height than the 17 ft. to 25 ft. indicated for a fly-less stage, will he obtain any advantage by doing so?

Though it might appear that every inch of head-room is useful, yet in practice it is hard to see where the value in the extra feet would come. The stage-manager on such a stage would still have to 'trick' his cloths, anyway, to 'get rid' of them—and the tumbler method has little advantage over the traditional roller method that needs so little head-room—so, in considered conclusion, it seems that if you cannot build a stage with an adequately high grid, it will be found less trying to your future staff if you abandon the idea of flying altogether and content yourself with 7 ft. of working head-room. A 28 ft. high stage roof is very little more good to anybody than a 20 ft.

Concerning the matter of a fire curtain: This important part of the safety precautions is a reasonably specialized piece of equipment, and its nature and method of installation must be a matter for consultation with an expert firm. It may, however, be useful to call attention to the existence of a new, flexible, rolling safety curtain, devised and made by the Hall Manufacturing Company. Usually the solid construction of a safety curtain has imposed a fixed condition that no theatre can install one unless it possesses flying space. It is now, however, possible to incorporate a safety curtain of the new type on stages possessing no more than the 'grid substitute' discussed in this chapter.

Every stage designer should be acquainted with the essential need for an adequate 'lantern' or automatic vent above the stage, to be used in conjunction with any safety curtain. Freeman's important demonstration that the gases engendered by a fire on the stage may be of sufficient volume to force any safety curtain outwards from its guides unless relieved by an adequate vent above, should be studied by all readers (see Bibliography).

(e) *The Counterweight System*

A modern alternative to the hand-worked flying system is the counter-weighted system, and in most circumstances it has very considerable

ESSENTIALS OF STAGE-PLANNING

advantages, but the merits of the two systems are different and after outlining the technicalities of the counterweight system, consideration will be given to the advantages and disadvantages of the two methods, when used in small theatres.

There are two forms of counterweight system. The principle of the simpler, or single-purchase, system is as follows (see Fig. 40):

Firstly, the separate lines are replaced by wire ropes. These are of a length to reach from the stage up to the grid and across to the headblock and just below, but there they stop. They do not continue in descending ends to be made off to a cleat as in the hand-worked system, but are attached instead to the top bar of a counterweight cradle, which is arranged to rise and fall vertically in metal guides.

Since these ends of the lines are rigidly fixed, it follows that the other, or stage, ends must also finish in an unvarying attachment, and thus they are made off permanently round a *fly-bar* or steel tube. To this bar the top batten of the scene-piece is fixed by some variable attachment such as a chain or strap, and the piece is carefully 'deaded' at this point once and for all.

The counterweight cradle is incorporated in an endless line running down to the stage, round a pulley, up to the headblock on the grid, and down to the top of the cradle again. As it passes the pulley at stage level, a form of releasable check or brake is built in so that the line may be stopped at any point.

The cradle is carefully weighted from the *loading floor* just underneath the grid so as properly to counterbalance the weight of the scenery, and when all is ready the piece may be raised or lowered by one man releasing the brake and giving the endless line a pull in the required direction, applying the brake again as soon as the scenery is in position.

Such a system may be worked either from stage level or from a fly-floor. In the other system—that of the double-purchase (see Fig. 41) an arrangement is made to shorten the vertical travel of the cradle (in cases of difficulties in the shape of the building) by taking the 'endless' line through a slightly more complicated course, so that it becomes no longer endless, but descends from an attachment near the headblock down to a pulley on the top of the cradle, up again and over the headblock, down to the brake and lowest pulley (here situated upon a raised gallery—the fly-floor). Thereafter the line rises again, circles a pulley at the bottom of the cradle and descends again to its final attachment near the lowest pulley.

THE 'ROOF' OVER THE STAGE

The point from which the lines are worked is thus raised clear of the stage. But the double-purchase system is only a special adaptation to difficult conditions and it involves more weights and thus is more difficult to work and to control.

Comparing the counterweight systems and the hand-worked system of lines, each has its own particular advantages, and these should be clearly distinguished otherwise an attempt to use one system for some method peculiar to the other may lead to disaster.

A counterweighted system of flying has these advantages:

(a) A great saving of labour in setting and striking scenery during the performance.

(b) Since all lines in a counterweighted set are always fixed at their ends to common sources, no single line can slip and so cause, for instance, a pucker in the hanging of a cloth.

(c) All 'deading' (or adjusting for correct hang) is, once fixed, always correct and cannot alter.

(d) Since wire ropes are used, changes in length due to atmospheric differences are nil.

The advantages of the hand-worked system are:

(a) A saving of time in the original hanging of all scenery (since no counterweights have to be rigged).

(b) The initial adjustment of the hang of a piece (or its 'deading') is quicker, since it can be achieved by independent tightening or loosening of one or other of the lines, though it is as easily lost again.

(d) The hand-worked system is always much more efficient for handling ceilings.

(e) 'Brailing', or pulling a cloth backward or forward into a better alignment, is possible only with the hand-worked system.

On the other hand, lines in a counterweight system may be spaced somewhat closer together. A wider choice of alternative sets is thus allowed in a given space, and hence the need for brailing is less frequent.

(f) Once a piece is lowered to the stage, the lines may without danger be detached and taken up again, but with the counterweight system the weight of the piece must remain on the lines until the counterweights are adjusted—or the fly-bar will 'run away' on its own.

In conclusion, the hand-worked system is more flexible, needs fewer stage-hands for original adjustments, but more to work during a show; the counterweight system is quicker once preliminary work is done, needs fewer

ESSENTIALS OF STAGE-PLANNING

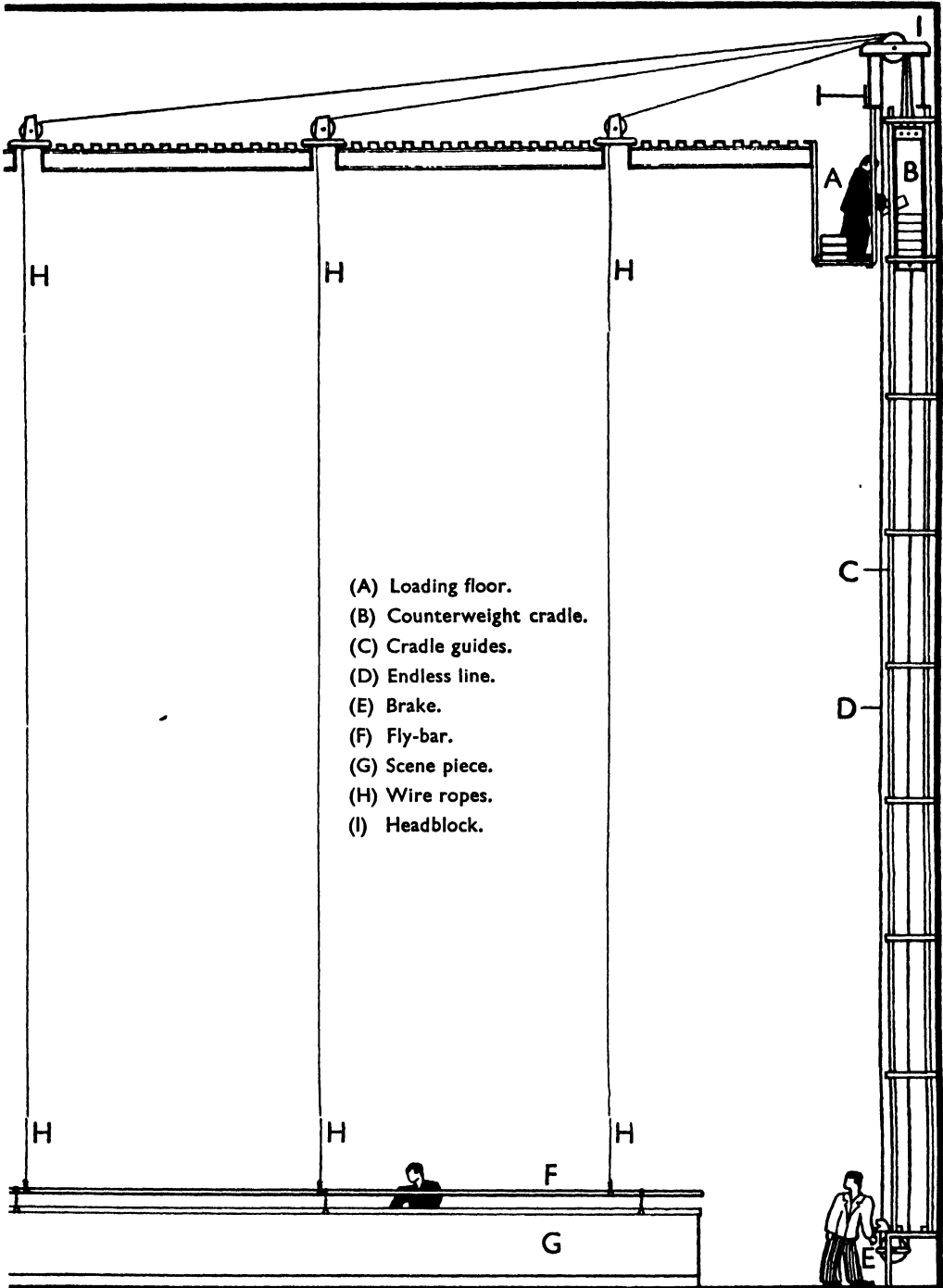
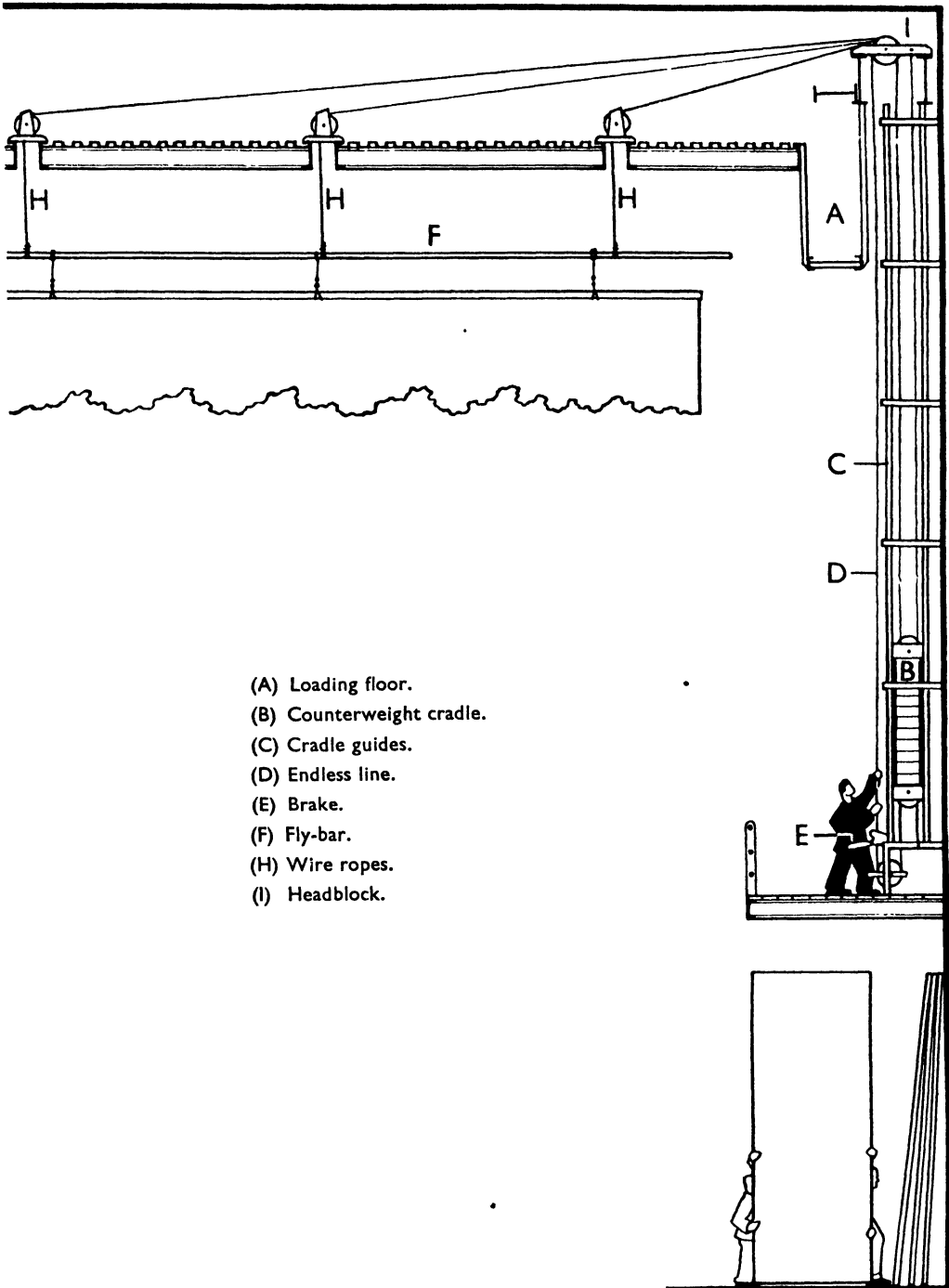

Fig. 40. The Working of the 'Single-purchase' Counterweight System.

THE 'ROOF' OVER THE STAGE



- (A) Loading floor.
- (B) Counterweight cradle.
- (C) Cradle guides.
- (D) Endless line.
- (E) Brake.
- (F) Fly-bar.
- (H) Wire ropes.
- (I) Headblock.

Fig. 41. The Working of the 'Double-purchase' Counterweight System, involving shorter travel for the weight-cradles and so avoiding encumbrance to the wing-space.

ESSENTIALS OF STAGE PLANNING

hands to run when adjusted, and is far better for working a set show. It is generally less suitable in repertory work, where very frequent changes of stuff have to be made.

It will be seen from the above account of the two systems that both have advantages of their own; it follows then that the best-arranged grid provides for a certain number of counterweighted sets of lines, supplemented by a number of hand-worked sets. The relative proportion of one to the other, and the placing of each, is for decision with technicians and after analysis of the future requirements of the stage and of the styles of production to be used upon it.

CHAPTER FIVE

THE STAGE BACK-WALL

WHEN we turn from the two 'sides' of the stage already discussed—the floor and the 'roof'—and approach the third side, the back-wall, we encounter an important new factor. So far we have been considering material things—a platform and a grid. Now the human element comes in. In one or all of the side walls of the stage we shall have to provide carefully-considered means of access for the men coming to work the stage and the men coming to work upon the stage. In other words, the surrounding walls must contain entrances, and we have to decide the best places for them.

(a) The Need for a Passage Across

Before discussing means of entrance from the rest of the building, facilities must be provided for crossing from one side of the stage to the other without going through the acting-area, or being observed by the audience.

This is surely an elementary point and yet it is overlooked on many small stages. It will affect the planning in one of three ways: (a) either an intercommunicating passage must be made behind the back-wall of the stage, or (b) steps down to a cellar must be sunk either side and communication established between them under the stage, or (c) the stage back-wall must be built sufficiently far back for crossing-space to be always available between it and the deepest limit of any set to be built on the stage.

We need hardly point out that the lack of intercommunication between the wing-spaces during performance is a very grave limitation. An actor must be free to get from his dressing-room to either side of the stage at need, or else one of two things must happen; the production will have to be re-arranged to force all entrances to be made from an arbitrarily fixed side, or the actor must cross the scene and take his place off-stage *before the curtain rises* and there wait for his entrance during whatever space of time the script of the play demands. Opportunity to change costume or renew make-up or to rest will be seriously curtailed.

Certain disadvantages, however, attach to all three of the solutions given

ESSENTIALS OF STAGE-PLANNING

above. The simplest—crossing the stage behind the back scene—may, on a small stage involve leaving only the narrowest passage possible between backcloth and back-wall in order to avoid cramping the acting-area, and then one has to reckon with the disturbance caused by an actor passing in a hurry and the consequent billowing of the backcloth from end to end, unless elaborate methods are taken to screen it.

To cross beneath the stage involves stairs, and, in the first place, no stair, or even step, should occur in the path of any actor or stage-hand who may be called upon to move quickly and, not infrequently, in total or partial darkness. In the second place, narrow and twisting stairs are troublesome and sometimes quite impassable to players in period costume (especially crinoline skirts). Moreover, in using the underground route, touch with the stage is frequently lost and cues may be missed. And the same objection of losing touch with the stage applies to the separate passage at stage-level built behind the back-wall.

On balance, the best method seems to cross behind the scene on the stage itself, provided that ample room is available to permit the crossing without crowding and without disturbing the hang of the backcloth.

If, on the other hand, a passage is built outside the stage, then this introduces us to the matter of openings in the back-wall to communicate with it. Generally the best arrangement is likely to be to have two doors, one toward either side the stage, not, however, completely in the corners, since access there is liable to be hindered by packs of furniture. Ideally, the outer post of the door should line up with the edge of the fly-floor above (see, for example, Fig. 20).

A cross-bridge above, giving communication between the two fly-floors is sometimes built against the back-wall. In practice, however, this cross-bridge is probably better situated for most purposes down-stage against the back of the proscenium wall (see p. 85).

(b) *The Nature of the Cyclorama*

Further considerations concerning the treatment of the stage back-wall will introduce a controversial subject which, though widely discussed, is seldom fully understood, therefore, some clearing of our ideas on the nature of the *cyclorama*, and some agreement as to the legitimate application of the name, are called for at this point.

The specific function of a cyclorama, at its introduction, was not primarily to provide a surface for a particular lighting technique. The

THE STAGE BACK-WALL

cyclorama was introduced into England as early as the 1860s primarily as a means to bring about a revolution in scenery-technique whereby the old system of borders and wings might be abandoned. It was a step in the development towards naturalistic setting, as may be seen in the following highly significant passage, published in Charles Dickens' magazine, *All the Year Round*, for 31st October, 1863, and describing the innovations then in hand under Charles Fechter at the Lyceum Theatre:

‘ . . . Many beautiful and interesting effects again will no doubt be achieved on this new stage by means of what may be called “closed in” scenes. It will be possible to try such effects, not only in the case of an interior shut in above with a ceiling, but in representations of out-door scenery. It is in contemplation at this theatre to dispense entirely with the use of those horizontal strips of canvas which were alluded to somewhat disparagingly at the commencement of this notice, and which are technically called “borders”, or at most only to employ them in scenes so nearly covered with foliage that they will not appear. In open out-door scenes, where, for instance, the open country, or perhaps the open sea, extends far away into the distance, the sky will close the scene in overhead: an unbroken canopy extending from a certain point behind the proscenium and high above it, over the stage, and away to where, at the extreme backward limit of the theatre, it mingles softly with the horizon. One may, without being too sanguine, believe that this great arched canopy, spanning the stage from side to side, and from front to back, will lend itself to all sorts of beautiful and truthful effects. With trees, or rocks, or whatever else may be needed at the sides—not, indeed, pushed on in flat pieces parallel to the proscenium, like the separated joints of a screen, but planted here and there, as Nature plants, carelessly and irregularly—it will be possible so to close in an out-door scene, as that there shall be really no flaw or weak place about it, no unfinished gaps to which the scrutinizing eye can wander in the confident hope of ascertaining “how the trick was done.” ’

This then was the attitude which marked the coming of the cyclorama in Dickens' day. That these projects never fully matured shows the scheme had some disadvantages. Its history was to be strangely different from what was forecast here.

For the innovations at the Lyceum were short-lived. The idea was, however, followed up on the Continent. There, certain new systems of stage

ESSENTIALS OF STAGE-PLANNING

scenery and of stage building were coupled with advances in lighting technique, and among the results were the Fortuny system, the Asphalæian system, and the Schwabe-Hasait; the first and last principally directed towards lighting and the second to elaborate hydraulic machinery. All these

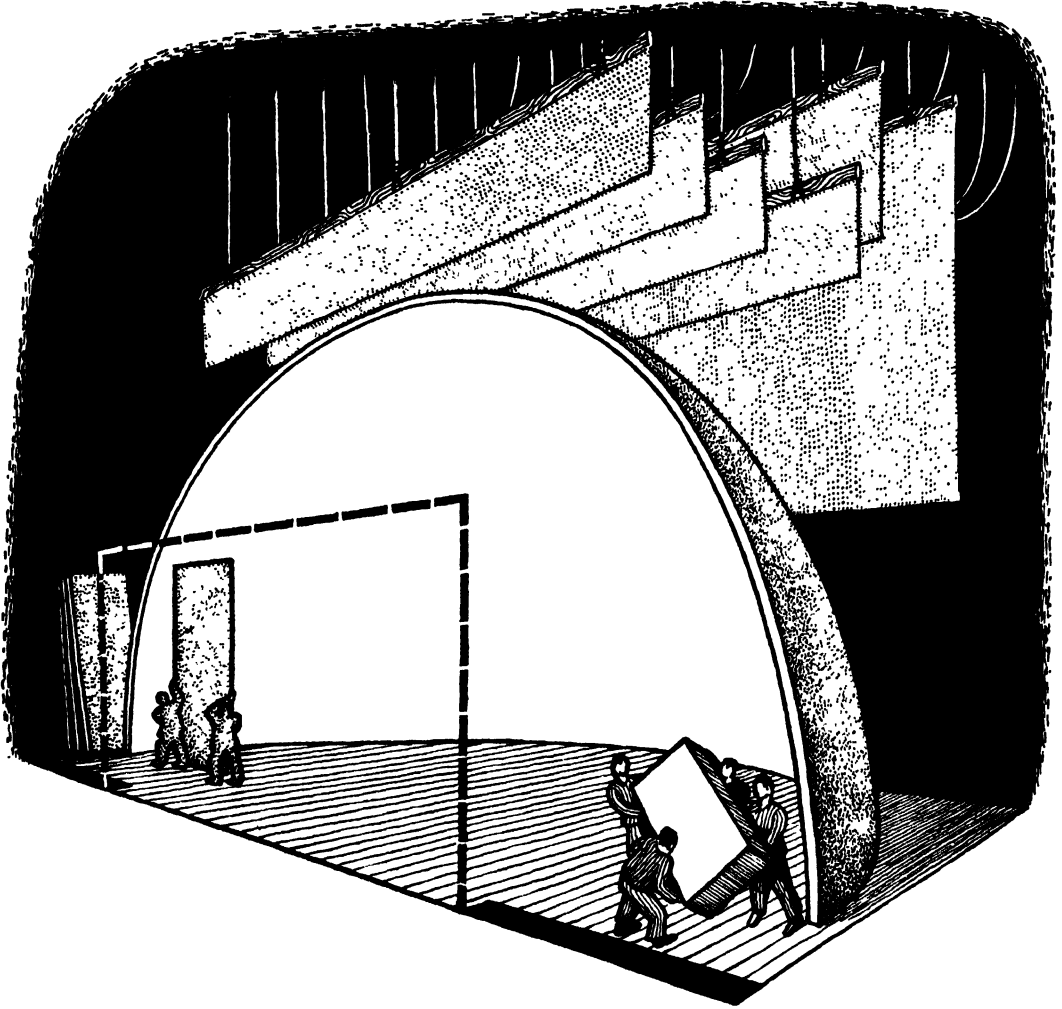

Fig. 42. The 'Full Cyclorama' in the Form of a Quarter Sphere. Such a cyclorama, while allowing wings and borders to be dispensed with in scenes which do not need them, unfortunately also prevents their use in scenes where they might be required. Most fly-lines are blocked, and little space is left at the sides for the hand-shifting of scenery.

depended, among other things, upon a great, curved and domed back-wall, possibly approaching the complete quarter-sphere.

But it must be thoroughly understood that with this great enveloping background a completely new technique of scenery was essential (see Fig. 42).

THE STAGE BACK-WALL

The flies could no more be used (or used only very restrictedly) and only the narrowest interval between the front edges of the great cyclorama and the proscenium permitted any side-striking of scenery from the stage into the wings. With a full cyclorama, no form of stage is truly practicable except the revolving or sinking kinds. The cyclorama brought its great innovations, but it so strictly limited all forms of production to its own specific conditions that the whole of the traditional technique was threatened. So the spread of the full cyclorama system in all its completeness was very markedly checked on account of more than one consideration. Indeed, with the passage of time and increase of experience, only a few specialist theatres came to adopt it whole-heartedly, and these, to avoid its limitations, generally had to modify and truncate its use.

Though further experience proved the limitations of the full cyclorama, there remained certain aspects of it that were capable of general use (see Fig. 43). Some of these came to be widely applied, though it must be admitted that even its limited application may bring serious disadvantages, as the master-carpenter on many a small stage where an expensive steel and concrete, curved and domed back-wall has been installed, can witness.

First of these is that a cyclorama is practically useless with any form of box set and only of partial use with some forms of wing-and-cloth setting where these are adapted to show a landscape, in former days painted along the bottom of the backcloth, now cut out in the form of groundrows, leaving a portion of the cyclorama behind instead of the discarded sky-part of the backcloth.

This may indeed produce a very attractive effect—but for such a purpose a properly-made, well-hung, plain sky-cloth is in every way as good.

If a plaster cyclorama is installed, even with curves of strictly limited extent, it is likely to get in the way of scene-shifting to a quite troublesome degree whenever traditional types of set are used with it; moreover, its upper curve-over will prevent the use of the up-stage fly-lines, and its projecting side edges will hinder the shaping of sets upon the stage, and may interfere with smooth scene-shifting and packing. It must be remembered that the vast majority of modern plays are set in interior scenes, and it is for the normal interior scene that the cyclorama is of least use. There is a conflict here between the means which the drama demands of the stage and the means the stage offers for the use of the drama.

But the other side of the shield must not be ignored. It must be very clearly understood that the above strictures apply only to the general,

ESSENTIALS OF STAGE-PLANNING

everyday styles of setting. With many conventionalized styles—often precisely those which offer by far the most scope for artistry—depending as they may on the establishment of cut-out or built shapes before a wall of light—the cyclorama idea is essential, and, when properly used with the

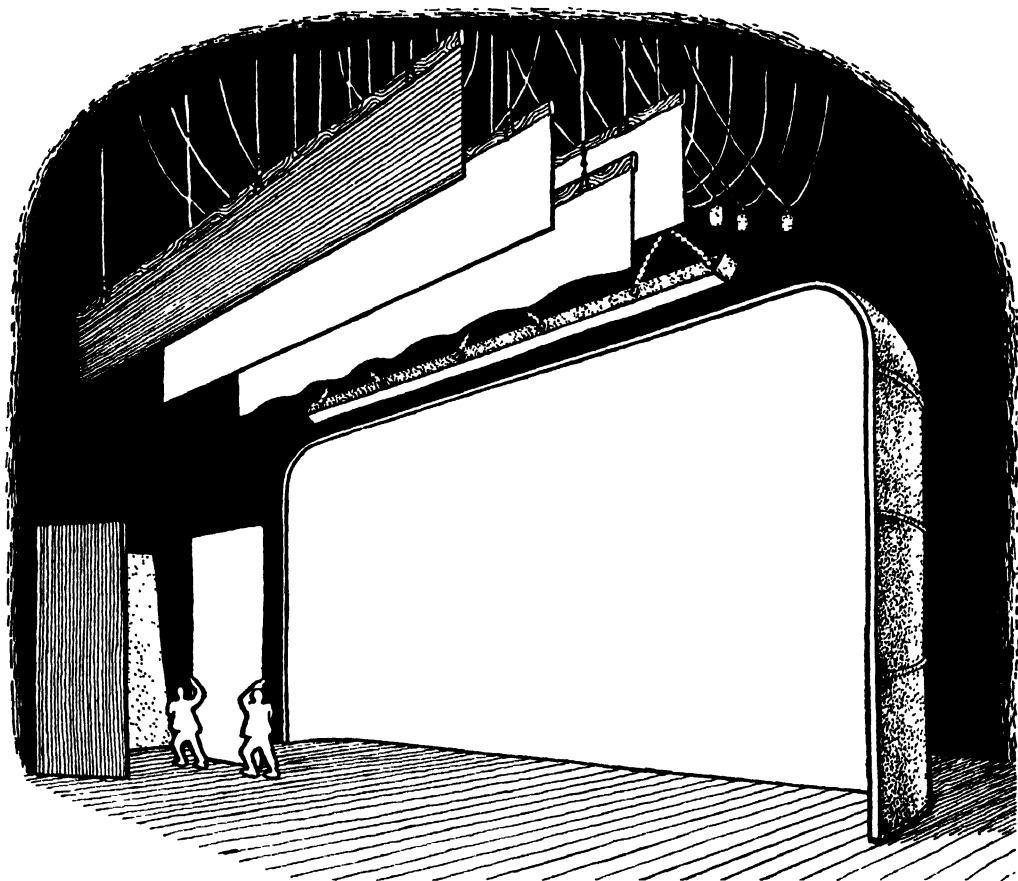

Fig. 43. The 'Curtailed Cyclorama', in the form of a flat wall with curving ends and top. This form frees all but the upstage fly-lines (here shown looped away and weighted with sandbags), and allows fairly free access to the side scenery for striking.

inclusion of an inner proscenium, is, both artistically and physically, economical of means.

Before, however, unquestioningly embarking upon the inclusion of a cyclorama in any new stage plan, the designer should carefully consider the relative merits of a *panorama cloth*. A panorama cloth serves many of the purposes of a cyclorama, and it is indeed often spoken of as a canvas cyclorama. But we need to be particular not to mix our terms here. The name

THE STAGE BACK-WALL

'canvas cyclorama' may be confused with the rolling cyclorama cloth. This is a tall back-cloth working on a curved railway and capable of being wound off to one side upon a great vertical drum, which would thus seem to offer the advantage of being removable out of the way at need. But in practice the vast column of rolled canvas, present at the side of the stage when the cloth is not in use, may be nearly as great a nuisance, with its permanent railway, as a built cyclorama.

The panorama cloth (Fig. 44), or 'pan cloth', is an old-fashioned and

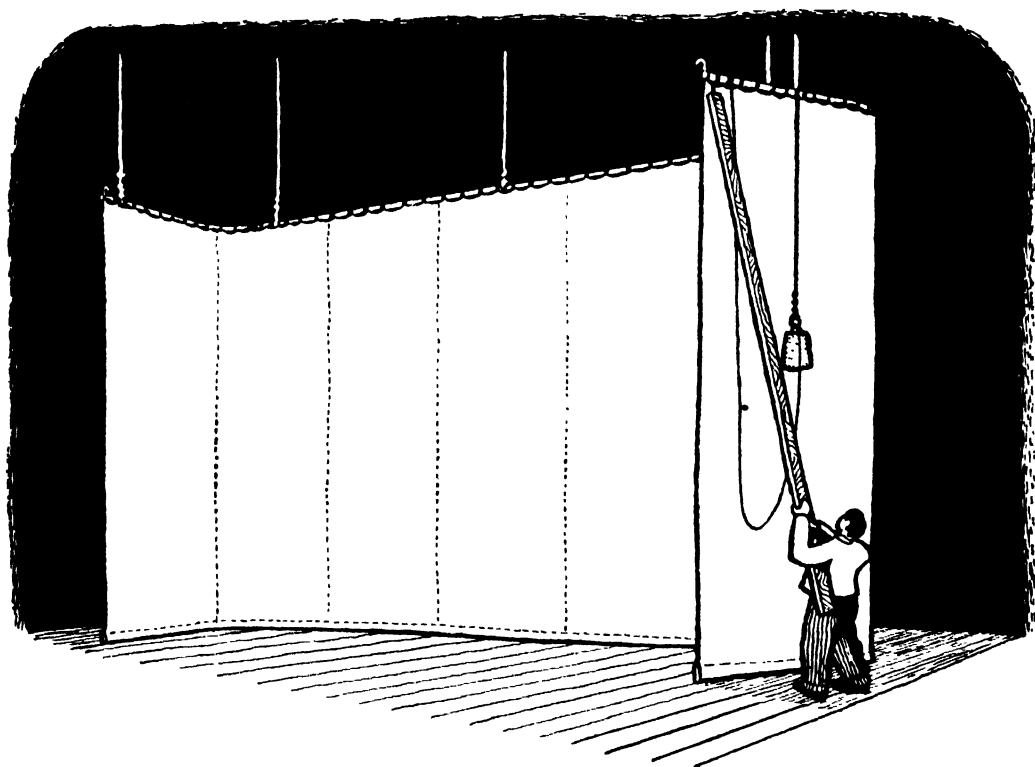

Fig. 44. The 'Pan Cloth', or Armed-batten Cloth. A useful substitute for the built cyclorama. The cloth is hung on a batten with hinged arms, the latter suspended on a second set of lines. The base of the cloth is weighted by a chain running through the hem. Such a cloth may be easily flown by slackening the front pair of lines, while carrying each arm back to the main batten (by means of the attached 'monkey-stick') to be hooked thereon. The two down-stage lines are disconnected by a snap hook below the sandbag, and are flown separately, while the folded cloth may now be flown in the normal way.

well-tried device which consists merely of a very wide backcloth whose ends are brought forward in a curve, and continue for a short way down-stage. These lateral arms may afford certain hindrances to flying stuff, especially to the feed-cables or 'tripe' of the up-stage lighting batten when

ESSENTIALS OF STAGE-PLANNING

this is fed from the end and not from the centre. But the pan-cloth retains the great advantage of flying; it may, for instance, be raised 7 ft. above the stage to give full clearance to stage-hands and furniture-shifting, and yet serve much of its original purpose.

All this affects the designer of a stage in so far as he should be aware that a permanently-built, plastered cyclorama even of limited size should not be included in the scheme for a normal stage except after the most careful consideration. Even then he should proceed with the utmost regard to all the surrounding features, and especially should he be reserved as to how fully he allows the development of the curves at the sides and top. And he should remember that though tried and often useful alternatives exist, at any rate for the curtailed form of cyclorama, the un-curtailed cyclorama demands a specially-designed mechanism for scene-change, or imposes very severe restrictions upon repertoire and upon production style.

Of course, an occasion may always arise where these conditions, with their particular limitations and advantages, are just those sought by a management or director, and then the policy of the theatre will be such that a cyclorama will be the ideal solution. A case in point was the Festival Theatre, Cambridge, during the régime of Mr. Terence Grey. No better example both of the brilliant possibilities and the considerable limitations of the curtailed cyclorama system could be offered than in that exciting enterprise. Those interested should refer to the plans of the building which may be found in Harold Ridge's *Stage Lighting* (Heffer, 1930).

Finally, there remains one set of special circumstances where a restricted application of cyclorama technique will bring a surprisingly valuable result. These circumstances are found, oddly enough, on the small and very limited stage, and they will be discussed in the next section.

(c) The Limited Application of the Cyclorama System to Certain Small Stages

It will be remembered that the original function of the cyclorama was to economize scenery and to obviate, or reduce the need for, borders and wings. In one set of circumstances, it may achieve this function in a remarkable degree and yet involve the stage in few of the usual difficulties resulting from a fixed cyclorama.

Consider a small stage with limited headroom, situated possibly in a school, or where a strict frugality of means is imposed.

THE STAGE BACK-WALL

The stage (see Fig. 45a) may normally require three borders, two wings a side, and a full backcloth. If now the back-wall of the stage be rendered flat and plastered, and the ends of the wall and its upper junction with the ceiling brought forward in a curve or cove—even a very restricted one of only a couple of feet in radius—it may be possible to reduce the

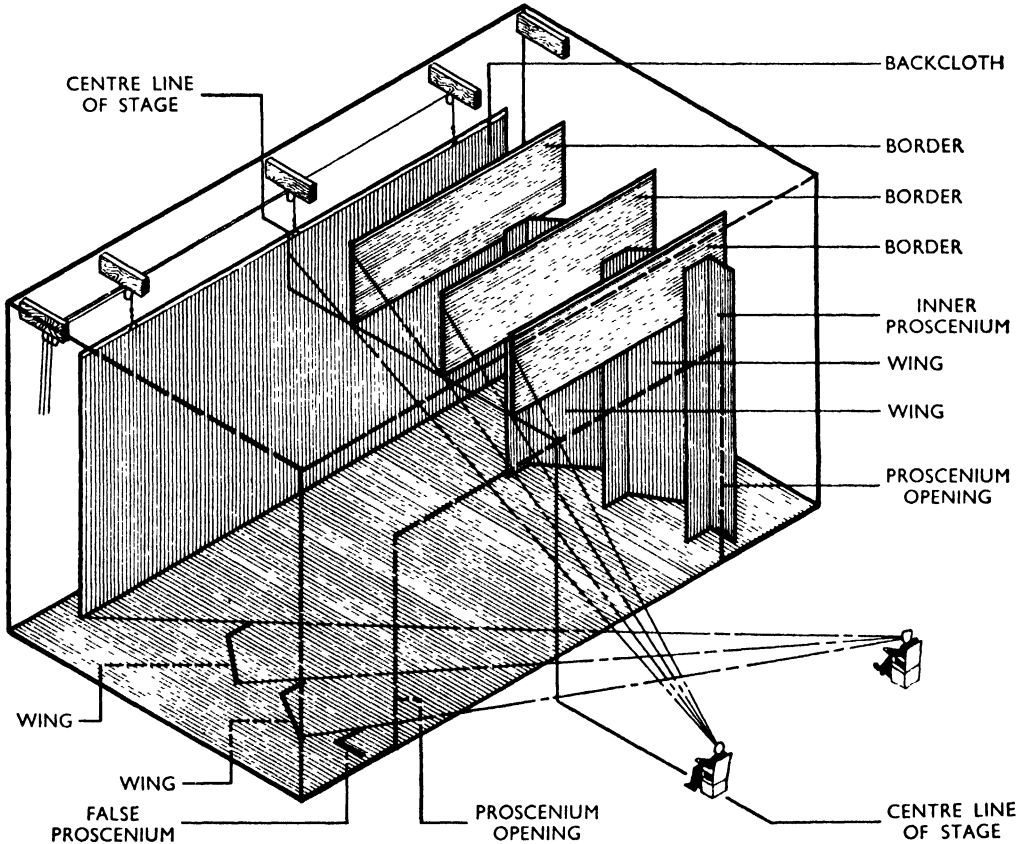

Fig. 45a.

scenery at once to one wing a side and one border, eliminating backcloths and substituting groundrows against the sky-wall backing. The addition of a shallow inner proscenium now permits one to dispense with the need for even these last wings and border (see Fig. 45b). The stage will mask itself, and scenery can be limited to the use of a single set-piece or a pair of chairs if necessary, while on the other hand almost as much liberty is allowed as before to build an elaborate full set if required.

The principle upon which this scheme may be worked out, together with a method of testing its suitability for any given stage, and full practical

ESSENTIALS OF STAGE-PLANNING

figures, may be found in *Proscenium and Sight-lines* (Richard Southern, Faber, 1939).

The above considerations make it necessary slightly to modify our recommendations concerning the stage back-wall so far as relates to the back of certain small stages, and especially those in halls.

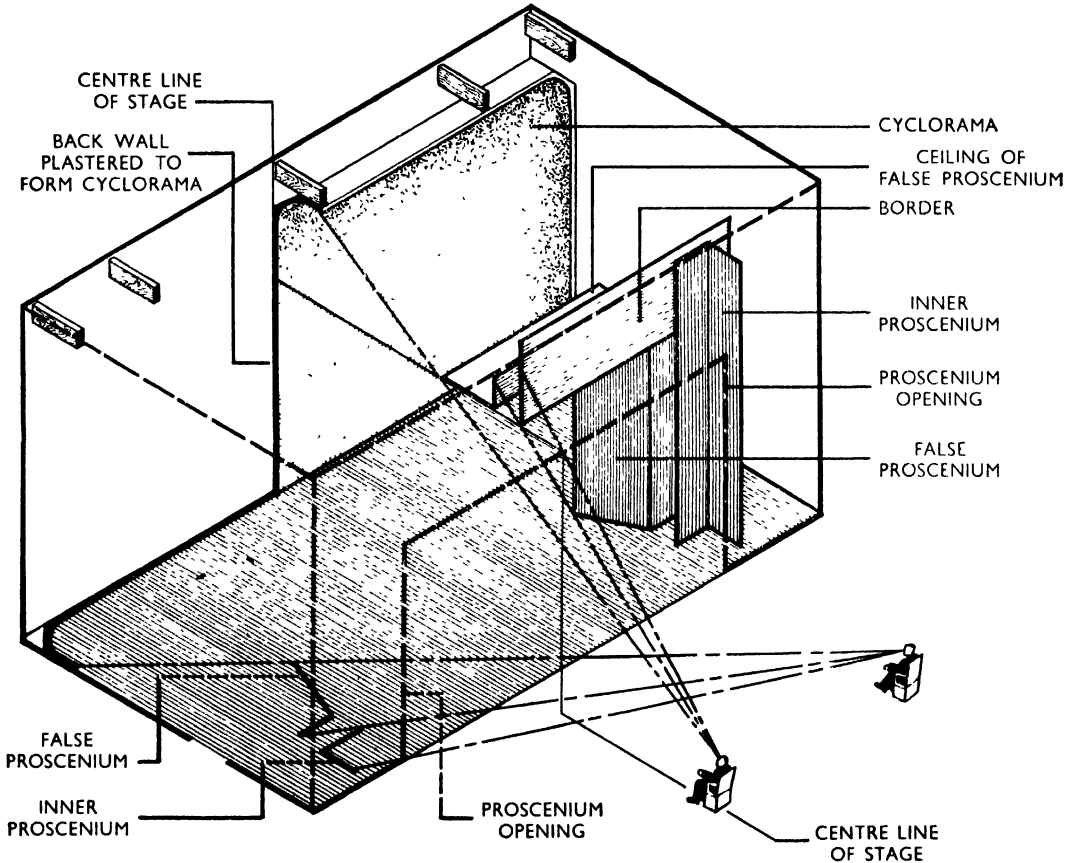

Fig. 45b.

Figs. 45a and 45b. Two figures showing, in (a), a stage normally set with wings, backcloth and borders according to the demands of the sight-lines, and, in (b), how a plastered back-wall, with curved ends and top, permits of a considerable economy of scenery.

To the designers of these we would say:

(a) Avoid incorporating any object whatever in the back-wall: no window, radiators, pipes, picture-rails, dados or skirtings.

(b) Render the back-wall flat, plaster and paint a soft, pale lilac-grey.

(c) Avoid doors in the back-wall and arrange for the stage to be approached from either side, but see that the doors are not so far down in the

THE STAGE BACK-WALL

side walls that the entrance of a group of players will immediately interfere with the assistant stage-manager in his prompt corner. About two-thirds of the way downstage is probably the best position (see p. 83).

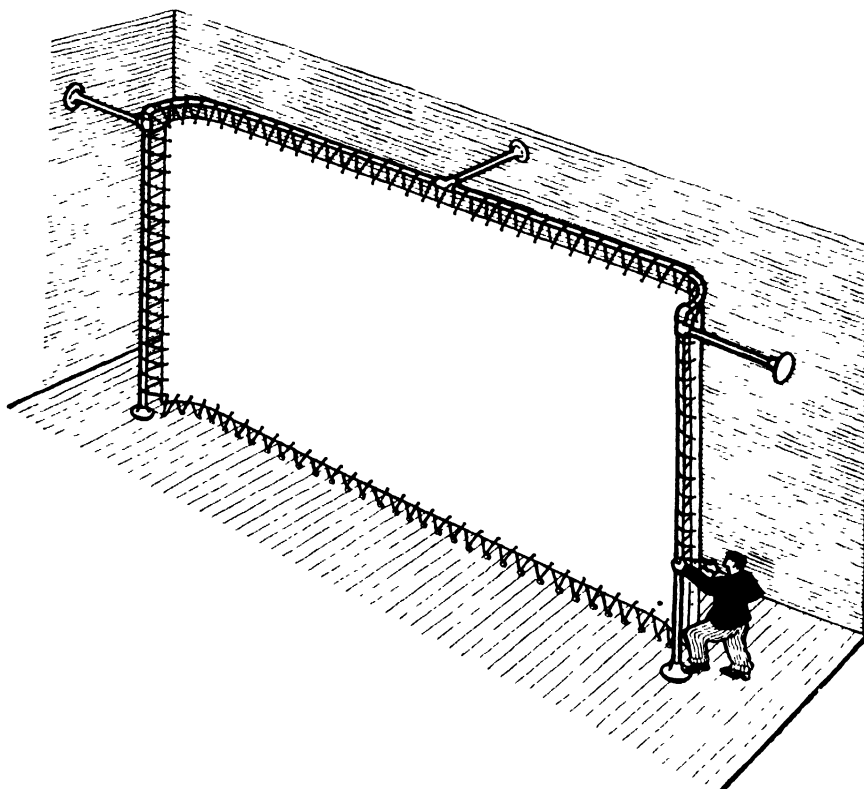

Fig. 46. A Simple Canvas Cyclorama for Small Stages, placed on a frame of bent metal tubing.

(d) Consult the method and figures outlined in *Proscenium and Sight-lines* and apply the method in so far as the figures show it to be advantageous upon the stage in question.

CHAPTER SIX

THE FRONT WALL OF THE STAGE

(a) *The Actor's Contact with the Audience*

WHEN we turn from the first three 'sides' of the 'cage'—the floor, the back, the top—and come to the fourth side, the side facing the audience, we meet one of the most controversial subjects in stage-design, and one about which there is even more confused thought than about the cyclorama.

To begin with, it might be objected that this side does not exist at all, that the 'cage' is open here, and hence that there is nothing to be discussed. But the front 'wall' of a stage is something more than an emptiness; it is the plane of juncture between the stage and the auditorium and it is the only aspect of the stage-cube (except its floor) of which the audience is directly conscious. The design of this junction is of profound influence both upon the appearance which the show will have for the audience, and upon the style the show will take under its producer. From its design will result much of the nature of the contact which the audience will be able to make with the players.

There is to-day a wide feeling that this contact between audience and players should be very close. To have the players observed by the audience from a distance so that they are conceived as 'something over there' in a more or less remote world or in a picture, their actions being watched impersonally from without, not partaken-in and experienced almost actively—is held to bring a coldness and sluggishness into the experience of theatre-going; in short to tend to make people not so *interested* by the theatre.

It is not the authors' present business to examine this matter at length, nor to lay down a definition of what the degree of contact should be between an actor and an audience. All the same they would be failing in their duty to the reader if they omitted to call attention to the existence just here of something often insufficiently considered in planning stages, and they wish to stress how important it is for the designer of any stage to consider in closest detail just what effect his design will have upon the player as he faces

THE FRONT WALL OF THE STAGE

the audience, and conversely what kind of impression the audience will be enabled to receive of the player. How will the player *feel* the audience from that stage? What will he look like to the audience *upon* that stage?

Remember that it is through this front 'side' of the stage that this contact and this impression are established (or fail to be established). Here is the 'portal' through which the show should go out into the audience. What things in the design of this 'portal' may tend to assist, and what hinder, this going-out of the play?

(b) *The Function of the Front Wall*

Let us for a moment try to visualize a show performed on a typical stage which has however been deprived of its proscenium or fourth wall (see Fig. 58).

At any normal show seen under these conditions, you would be conscious at once of an immediate distraction—for you would be able to see round the sides and over the top of the scene. The impression you would have would be exactly what you receive in a film-studio when you look at the set from a position well behind the camera. The whole scenically-irrelevant world of workmen, lights, lines, waiting players, packed furniture, backs of flats would be visible. But you have only to advance and peep through the camera and you will see now only what you are meant to see. All is neat and complete; the lens is so distanced from the scene that the distractions of the working-world are well cut off, and the scene takes on a new and unbelievable conviction.

Something of that function has to be served by the front 'side' of a stage. Around any normal scene there exists a periphery of working world that is scenically distracting. It must be hidden. It must be covered by a mask. This fourth 'side' must be a very solid thing even if much of it has to be cut out into an opening.

What is the ideal form for such a mask?

Unfortunately, the matter we have now to face is so controversial that we must break off at this point to clear up a likely misunderstanding.

Certain advanced students of the theatre to-day claim that it is wrong to hide the off-stage working-world with a mask round the scene. These and other 'anti illusionists' have their theories. They hold that no mask is needed and the whole tradition of the design of stage and auditorium should now undergo revolution. Considerable interest has also been aroused by experiments with the 'arena stage'.

ESSENTIALS OF STAGE-PLANNING

It is because of such tendencies that the designer of a theatre to-day is placed in a grave quandary. A number of these revolutionary ideas have much good in them. It may be that in the future someone may succeed in converting the theatre into a new form (as it has more than once been converted in the past), and all designers should be wary of uncritical dismissal on the one hand and of equally uncritical acceptance on the other. The future will undoubtedly judge as the best theatre designer the man whose stage most easily fits that style of presentation which may have gained the ascendancy, whether it be our now-accepted style again, or a new one.

He has to decide to what extent he is justified in altering modern technique in theatre-design to incorporate something new, and all the time he must strive to see that it is kept consistent with current technical needs so long as they remain current.

By such an approach, we are led into the heart of the controversy and may now be in a better place to appreciate the real pros and cons of the movement for the abolition of the proscenium—by which is meant: ‘Let us get away from a fixed “picture-frame” through which the show is seen as in a box, and which imposes a technique where any advance by the player through the “glass” of this picture-frame, so as to establish a personal contact with the audience, is obviously an anomaly.’

(c) *The Proscenium and the Stage-mask*

If the authors may be permitted to put the ‘space stage’ on one side for a moment as a not-impossible, but not-yet-realized, conjecture, and to confine their attention to the range of normal styles of present-day production, they believe that some clarity may be brought into the question if we agree to distinguish two quite separable ideas behind the word ‘proscenium’, and insist that these two ideas should in future be kept distinct:

The two separate conceptions of the front wall of the stage are (a) as a mask for the working-world outside the scene, and (b) as a more or less elaborate architectural feature whereby the designer of the auditorium embellishes the end of the house opposite to the audience. These are two entirely separate and independent conceptions. When we talk of the abolition of the proscenium, it is the latter only which can be the object of our attack; the former is as essential as it ever was, and if it is removed it has straightway to be put up again—possibly in some slightly different form, but in effect fulfilling an identical function.

In the old days of the theatre the two were distinguished by calling the

THE FRONT WALL OF THE STAGE

former the 'frontispiece' and the latter the 'proscenium'. The term 'frontispiece' (rather regrettably perhaps) fell out of use and we had a succession of substitutes—the tormentors, the pros. wings and border, the inner proscenium, the false pros. and so forth—all unsatisfactory terms. Perhaps we might re-christen it as the stage-mask or mount. But whatever it be, this essential fact arises out of it: *You may do away with the proscenium, but, as things are, you cannot do away with the stage-mask.*

(d) Concerning the Abolition of the Proscenium

Let us seek to explain what exactly a proscenium is, and what is involved by the abolition of the proscenium. Previously we have spoken of the proscenium as *the plane of juncture between the stage and the auditorium.* Imagine now, therefore, the most simplified scheme possible for a stage and the most simplified scheme possible for an auditorium, and then seek to join them together, so as to see how the proscenium comes in.

The result is Fig. 47, and what it shows is, within certain limits, an

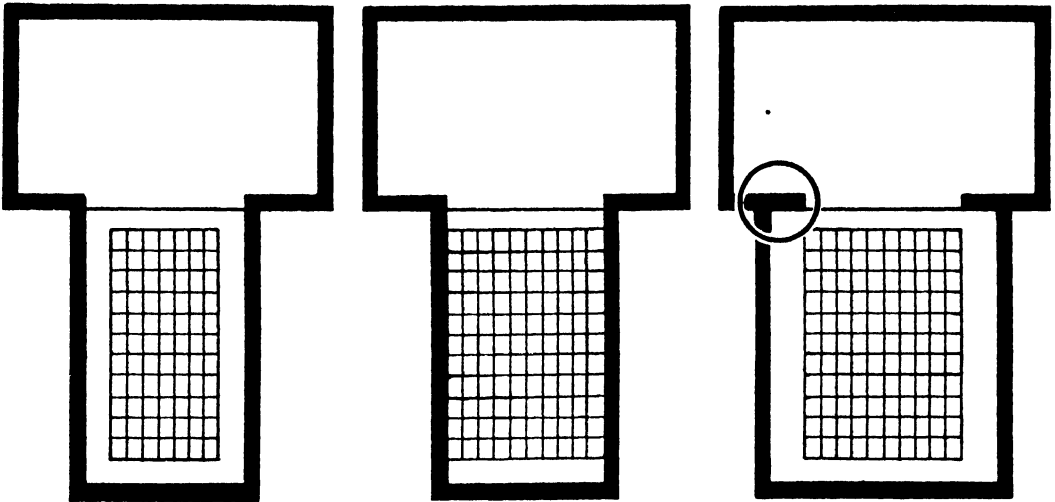

Fig. 47.

Fig. 48.

Fig. 49.

ideal theatre design. It has a simple regular stage, with no interfering corners, but with clear and adequate wing-spaces. The block of audience is disposed in the regular auditorium in such a way that no spectator is seated outside the extent of the proscenium opening; consequently, all can see the whole scene. The side walls of the auditorium run to the front of the stage and there stop dead; they cause no fuss and inflict no complication upon the scheme or upon the stage-workers. This relation of stage to auditorium is in

ESSENTIALS OF STAGE-PLANNING

principle, though not in detail, the same as obtained in the early Restoration theatres.

One criticism might be levelled, however, towards this little theoretical plan—namely, that the side gangways, being within the extent of the proscenium opening, are taking up good seating space. Spectators could be situated (so far as seeing goes) in these gangways and still obtain a perfectly comfortable view of the stage.

Let us then, for the sake of argument, fill the whole width of the auditorium, as it now stands, with seats by continuing the rows to the side walls, ignoring gangways and local regulations for the moment. We still have an excellent disposition of spectators (Fig. 48).

Now let us supply the deficiency in gangways by increasing the width of the hall, thus pushing the side walls outwards. The result is seen in Fig. 49. *But this figure now contains a completely new feature*, for, in the space included by the circular mark, there now projects a part of the front wall of the stage uncovered to view by our pushing out the side walls of the hall.

If we now continue our development, eliminating these strips of stage-wall by increasing the proscenium opening to match the width of the new house, we appear to be on the point of beginning the cycle all over again. But in practice a limit is set. We shall find that as soon as we increase the extent of a proscenium opening to a figure greater than about 36 ft. it tends to impose an uncomfortable swivelling of the head upon any of the nearer spectators who try to grasp the whole stage picture at once. They will risk 'tennis-neck'. Thus a stop is put to our development and, when we have reached this figure of 36 ft., we must accept the inward projection of the stage wall; we may not farther expand the opening of the stage, but our auditorium has grown beyond it in order to afford the gangway-spaces down beside our maximum width of seating. So there these side pieces are, and there they must remain. And it is to these visible parts of the front wall of the stage (which are left showing because an auditorium generally has to be wider than a stage-opening) that the name is sometimes given of 'proscenium'. In fact this is probably the most widely accepted interpretation of the term to be found to-day.

It follows now that the abolition of the proscenium (in this sense) is possible, *so far as concerns all small theatres*—and until we reach those whose stage-openings attain 36 ft. in width. Beyond this the abolition of the proscenium is not normally practicable.

THE FRONT WALL OF THE STAGE

Though the above-defined use of the word 'proscenium' is so common, it would perhaps be clearer to use the particularizing phrase 'proscenium-sides' for these inward-encroaching parts of the stage wall. If we agreed to do this, we should be able to say, with very practical justification, that proscenium-sides are necessary in large theatres but unnecessary in small theatres. In large theatres they must exist to limit the opening to the comfortable 36 ft. and yet permit the auditorium itself to exceed that figure in width.

One must not be misled by certain types of stage which boldly proclaim themselves proscenium-less but where, in practice, the stage-staff will have to introduce their own inner mount or stage-mask, either to reduce the opening to their needs (provided the sight-lines of the auditorium are not thereby seriously narrowed), or, in any case—and this is what really matters—because they must have something to cover up the working-parts of their stage beyond the scenery. In a design for a small stage this may be easily provided without introducing proscenium-sides, by building the stage wider than the auditorium, and one may then claim to have 'abolished' the proscenium (see Fig. 53). But in two other kinds of theatre—the small theatre whose stage is no wider than its auditorium (see Fig. 51), and a large theatre whose auditorium exceeds the 36 ft. of a maximum stage-opening—in both of these, proscenium-sides must normally be used, or some substitute adopted which in effect serves the same purpose.

(e) Advantages and Limitations of the Varieties of Proscenium

Assembling the above ideas in summary, we may list, and briefly comment upon, the following varieties of proscenium:

(a) (See Fig. 50.) A special decorative treatment of the end of the auditorium, generally in an arch-form, by which a 'frame' is made to the 'stage picture'. With this form the use of an inner-mask is usually necessary as well. This is the generally accepted meaning of the word to-day, and the closest to the tradition of the recent past. Its disadvantages are:

First: it too easily comes to be thought of as an 'architect's opportunity'. It may then become a riot of elaborate design which has no relation to the stage, being conceived as a grand decoration of the auditorium for the delectation of spectators during intervals, but possessing neither artistic nor functional connection with the stage and the show. Present feeling holds that there is an intellectual advantage if the clothing is more closely related to the skeleton underneath. Nevertheless, there is much to be said for the gay and

ESSENTIALS OF STAGE-PLANNING

pretentious glitter of the old-fashioned auditorium; it at least conveys an impression of the colourful past of theatrical tradition, and helps to set an



Fig. 50. The Proscenium Conceived as a Decorative Element, but with less regard for its functional aspect.

atmosphere of expectation and phantasy for an audience. We may lose much of the theatrical in those soberer decorations that mark the severe and more

THE FRONT WALL OF THE STAGE

functional styles of the day. But why should the advantages of a gaily-decorated theatre be incompatible with a more practical basic form for the proscenium?

Second: the normal style of proscenium tends by its assertiveness to set a boundary round the stage which strictly confines its contents behind the footlights. And the need to 'get across the footlights' is so deeply felt by the actor to-day as to be almost the first item in his creed. Such a proscenium must tend to emphasize the demarcation between stage and audience, and thus hinders the contact of the actor. His need is to get forward, but the picture-frame proscenium stigmatizes any such attempt as a 'moving out of the picture' and is thus an inconsistency.

Third: again such a proscenium is very unsympathetic to any attempt to bring the stage forward. If a forestage is added, it, like the advancing actor, 'comes out of the picture'.

(b) (See Figs. 51 and 52.) The stage-mask used in place of the proscenium. This form is most often found in smaller theatres where the side walls of the stage and the side walls of the auditorium are continuous. It is most simply exemplified in a plain hall where the drawn-back bunches of the traverse-curtain form the proscenium-sides and its pelmet the top (Fig. 52). Sometimes we have a complete, canvased framework, on the same lines, with the curtain working behind.

(c) The 'non-existent' proscenium (see Fig. 53). This nonce-term has been expressly chosen to mark the fact that, in the arrangement it implies, the functions of stage-masking are all satisfactorily attended to, and yet, at the same time, no feature exists which might become a barrier between audience and stage or to suggest any division between the two more than is implied by the edge of the platform.

This arrangement exists when the walls of the auditorium break off at

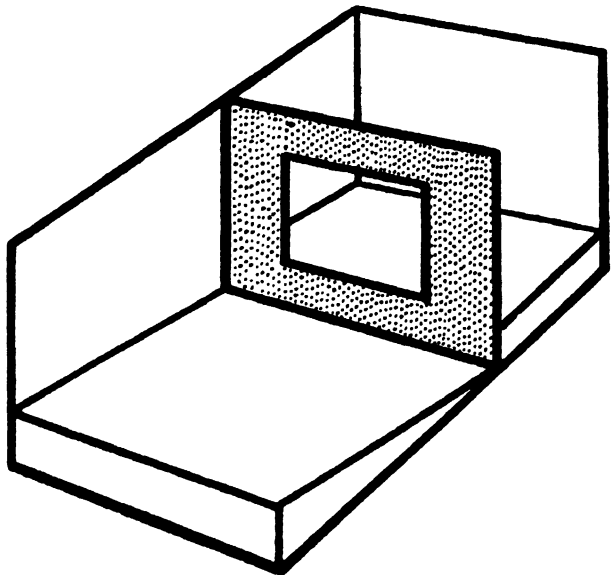

Fig. 51. The Functional Aspect of the Proscenium, as a 'stage-mask'.

ESSENTIALS OF STAGE-PLANNING

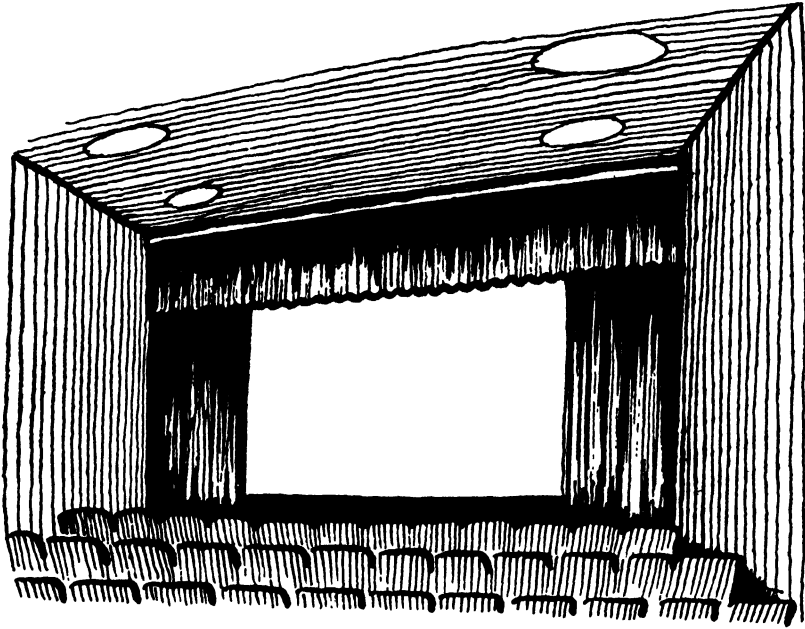

Fig. 52. The Typical Stage-mask of Curtains in a Multi-purpose Hall.

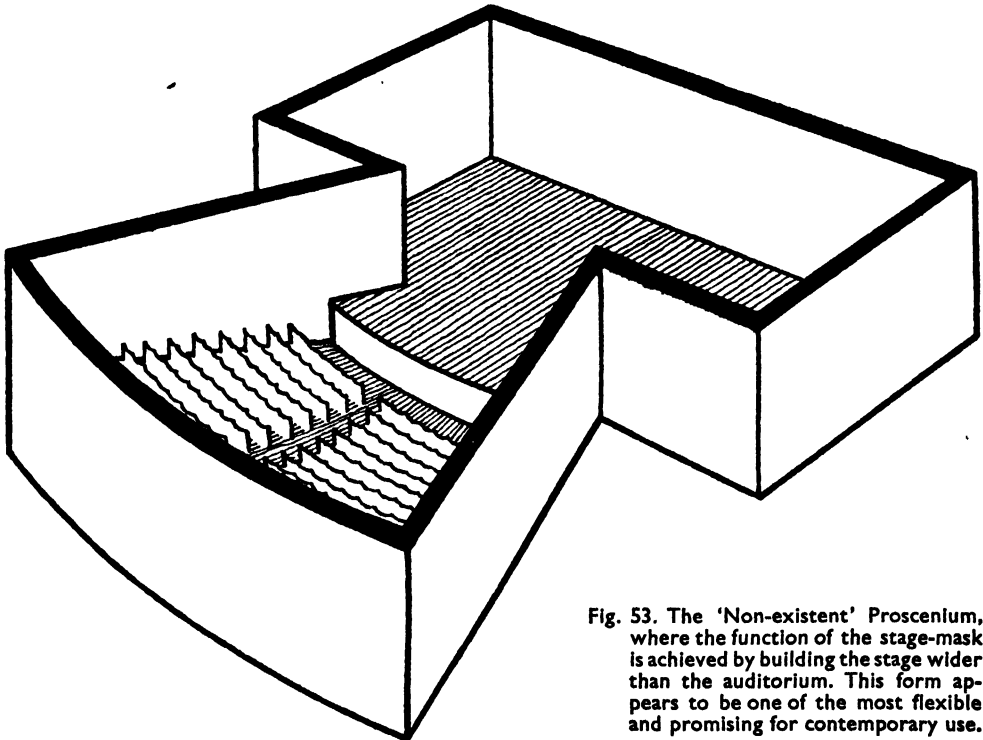

Fig. 53. The 'Non-existent' Proscenium, where the function of the stage-mask is achieved by building the stage wider than the auditorium. This form appears to be one of the most flexible and promising for contemporary use.

THE FRONT WALL OF THE STAGE

the stage with no emphasis on any idea of a transition to another world, and where the stage-masking is achieved simply by building the stage wider than the auditorium. The method is chiefly suited to small or medium theatres of up to 800 seats. Here no limit is imposed upon the use of a forestage if and when it is needed, and the widest opportunity is left open for development along any of a number of production styles.

Such a simple basic form is naturally not incompatible with a rich and gay decorative treatment if it is desired.

Upon such a stage, use can be made, just as upon the others, of a variable stage-mask to control the size of the opening at need.

In conclusion, we would make the following observation concerning the proscenium to designers of small halls: it is especially in the small-hall theatre that a traditional picture-frame proscenium may be a serious hindrance. Many such theatres pursue policies of unusual or experimental work. It would be regrettable to check development in these fields by restricting production-style within a permanent picture-frame proscenium. We may thereby sterilize a source from which a new movement might well spring.

(f) *The Size of the Proscenium Opening*

From the treatment of the proscenium itself we turn now to a much more direct subject—the opening within that proscenium through which the show is seen. Two possibly quite distinct openings may be in question here and we must distinguish them. There is the ‘stage-opening’, which is all that matters to the stage staff, and there is the auditorium-opening, which is that which confronts the audience, and through which they view the stage. But the two openings may be quite unlike in size. The auditorium-opening may be a vast arch, towering to the ceiling of the theatre, but the height of the stage-opening will be restricted by its mask and will *in no normal-sized theatre* exceed 16 ft.

In Messrs. Pitman’s valuable publication, *Who’s Who in the Theatre*, there is a table devoted to stage dimensions of London theatres. It is well set out and generally practical in all the measurements except those concerning the proscenium opening in columns 1 and 2. Here the width given in column 1 can only be accepted as the width of the built arch and does not indicate the presence or absence of tormentors; but—more important—in practically every case in column 2 it is the height of the architectural feature that is given and this may bear no relation to the highest practical working height

ESSENTIALS OF STAGE-PLANNING

of actual opening, nor to the bottom of the fire curtain. The figure should state the maximum height of the proscenium border or pelmet.

The limit of 16 ft. for the height of the stage-opening is frequently a surprise even to experienced theatre-people. It is not generally realized that no opening can be higher for the very simple reason that scenery is normally built of 18-ft.-high material—and the opening cannot be higher than the scenery; on the contrary, it must be some foot or two lower in order to mask the top. The figure of 18 ft. is the normal full size for all general scenery. Only on special occasions or for special theatres is scenery, in English procedure, built higher than 18 ft.

It will be at once apparent, that many typical theatres have auditorium-openings quite fantastically high, and, if so, it will be from some reason unconnected with the stage, and the stage-staff will cut down the effective opening to 16 ft. again by dropping a proscenium border so as to mask the top of their scenes.

The minimum height of an effective opening on a small stage is a less certain figure, but it probably hovers between 8 ft. and 9 ft. Anything lower tends to make an actor appear uncomfortably large and compressed.

Final decisions as to height of effective opening depend upon whether or no the auditorium is provided with a balcony or gallery. In such a case, a low opening may very seriously limit the view of the back scenery upon the stage. Any project for the proper interrelation of parts concerned should be tested by the method explained in *Proscenium and Sight-lines*, already quoted, by which it will be possible to see exactly what effect upon the sight-lines the adjustment of proscenium opening will have for any arrangement of auditorium.

The maximum width for the effective stage-opening has already been noted as 36 ft.

Concerning the minimum width, it is the authors' belief that useful work in normal production styles begins to be seriously hampered if the stage-opening is less than 18 ft. The reason for fixing this minimum limit is very simple; frequently in normal production one is faced with circumstances which demand a sideboard at one side of the stage, a settee in the centre, a fireplace on the opposite side and an armchair between settee and fire. This is one of the commonest layouts of a typical interior. Consider now the dimensions: allow 1 ft. 6 ins. for the sideboard-depth, 1 ft. for the fireplace and fender, 2 ft. 6 ins. at least for the diagonal measurement of an

THE FRONT WALL OF THE STAGE

armchair, 5 ft. for the settee. A total of 10 ft.—leaving 8 ft. to be divided between three intervals in which the actor is free to move. Such figures cannot be lowered for a normally-furnished play without seriously restricting your movement, or involving an unreasonable expenditure of ingenuity, or—and this is too often overlooked—seriously restricting your selection of plays.

(g) Functions of the Back of the Proscenium Wall

Upon the reverse face of the proscenium wall (see Fig. 57) it is usual to provide for certain essentials to the working of the stage.

The stage-manager's desk for prompt-book and time-sheets, with the cue-and-effects board above it, is most conveniently situated on stage level

at the back of one of the proscenium sides. If the conformation of the wall allows, the whole should be accommodated in an alcove so as not to cause projections from the wall-surface. Ideally the board and desk should be on the side wall of the alcove so that the stage-manager can face the stage, and they should be as near the proscenium opening as possible to facilitate his view of the stage (see Fig. 54). There is

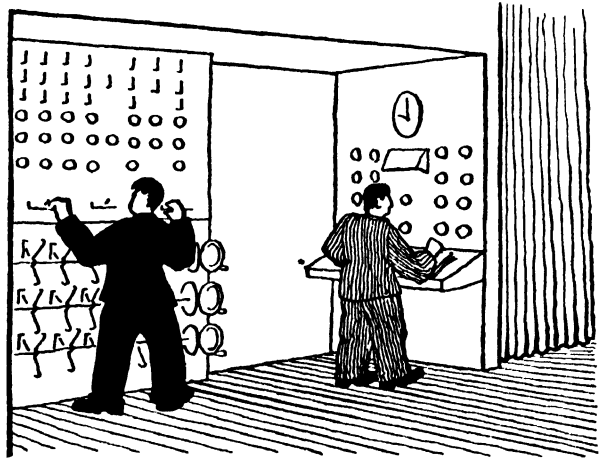

Fig. 54. The Stage-manager's Desk built into an Alcove in the Proscenium Wall. Such an alcove is here shown big enough to accommodate a small switchboard as well.

much to be said for separating the prompter from the stage-manager to save congestion at a vital working-corner, and providing the prompter with a second prompt-book and desk in a similar position on the opposite side of the stage.

The lighting switchboard is frequently placed on one of these walls, and it is ideal to have it set in the same alcove as the stage-manager, though a large board takes up so much space that it may have to be raised above him on its own platform. The platform, however, should never be allowed to project into the wing-space; such an encroachment is likely to prove a constant hindrance to the setting of scenery. A similar disposition on the opposite side is useful for housing a panatrophe.

ESSENTIALS OF STAGE-PLANNING

Pass-doors. Generally it is inconvenient to have the pass-door, between auditorium and stage, opening upon this somewhat congested space. It is better to plan it in a corridor outside the stage area altogether, in which case a removable stair to the stage over the orchestra-well, would be installed for the producer at rehearsals.

CHAPTER SEVEN

THE LEFT- AND RIGHT-HAND WALLS OF THE STAGE

(a) *Entrances*

TO turn now to the side walls flanking the stage is to come to a simpler subject. Our first concern here is with entrances—a subject which has already been touched in Section (a) of the chapter on the Back-wall. The doors to a stage may equally conveniently be situated at the back or at the sides according to the disposition of the rooms behind or beside the stage. Our present concern is with doors placed in the side walls.

If an entrance door is built in the side of the stage it should be situated about two-thirds of the way down from the back-wall. The object is to place it at the spot where it may interfere least with the work in the wings. A door far down-stage is liable to discharge the players, very distractingly, straight on to the important, and already small, working area around the stage-manager's or prompter's desk. On the other hand, a door far up-stage in the side is liable to hinder the placing of scene-packs which are usually best situated toward the back but which must not, of course, obstruct an entrance to the stage. The best arrangement is probably to allow room for two packs at the far end of the side wall, then introduce the door, then allow space for a third pack, and below that come on to the stage-manager's corner. But other factors may arise to upset this arrangement on a stage of limited size, and the suggestion is made only as a general guide.

In a theatre using a counterweighted flying system which is operated from stage-level, the entrance on one side of the stage must not come opposite the entrance on the opposite side, because no fly-lines can descend in front of a door; consequently, the fly-lines must, at any point where a door occurs, be taken down from the grid on the opposite side of the stage.

The entrance doors to the stage of a medium-size theatre should preferably be double doors, opening together to a clear 4 ft. 6 ins. in order to allow of the passage of wide costumes such as crinolines, and should always be provided with a means for hooking-back in the open position at need. They

ESSENTIALS OF STAGE-PLANNING

should open outwards, and be controlled by a light spring, but not one strong enough to make the doors difficult to negotiate for a stage-hand or player who has only one hand available. The door should contain no latch of any sort, since any noise of clicking must be strictly avoided, and the leaves should close upon a rubber buffer; in all ways, the doors should be as noise-proof as possible. Both leaves should be provided with a glazed spy-hole about a foot square at eye-height, so that the situation within may be seen at need without opening the doors. The handles should contain nothing liable to catch in a passing costume.

Upon a small stage, the entrance doors may have to be limited to 3 ft. in width, and should then consist only of a single leaf. There is little need, whatever the size of the stage, for these doors to be above normal height.

(b) The Scene Door

The scene door or dock door is intended for the introduction of scenery to the stage. It needs to be bigger than the players' entrance doors, though not so purposelessly high as it is often built. It possesses one important difference, however, from the entrance doors in that, since all scenery required in any show should generally be accommodated on the stage itself, the scene door may without disadvantage be buried under packs of scenery during the performance. It should be a double door, 6 ft. wide by 10 ft. high. The 20-ft.-high dock doors sometimes seen are without purpose unless they give directly on to a space where flats are stored upright. In the ordinary process of unloading scenery from a lorry and getting-in to the stage, flats are always carried on their sides and never up-ended to their full height, therefore a high dock door for getting-in is unnecessary. The scene door is generally most usefully situated in the up-stage half of either the right or the left side wall. To place it in the centre of the back-wall is to make the wall impossible for use as a plastered sky-backing.

In small stages where opportunity for a scene door may not be afforded, the scenery must either come in by the auditorium and be lifted and dragged over the stage-front—a barbarous arrangement—or it must make use of one of the actor's entrance doors. In the latter case the entrance door should exceed the size mentioned for it above and should be 7 ft. high by 4 ft. wide.

A further door sometimes necessary in the side wall is that to the property room. The situation of the property room, however, varies and no recommendation for its position can be given until the general set-up of the rooms at the back of the stage has been fixed.

THE LEFT- AND RIGHT-HAND WALLS OF THE STAGE

(c) *The Fly-floors*

The side walls of a stage beside accommodating packs and affording entrances also possess in most cases a working gallery built above the wing-space either side and called the 'fly-floor'. The primary function of the fly-floor is to keep the great lengths of rope-ends, and also the men working the lines, up out of the way of the already-busy wing-space on the level of the stage itself.

The narrower the fly-floors, the wider the space left between them for the hanging of scenery. (One of the important informative measurements for any fully-equipped stage is the distance between fly-rails; upon that depends the length of the battens for borders and cloths to be used on that stage.) But the minimum width of a fly-floor is dictated by the work to be performed there. Primarily that work consists of the lowering and hauling-in of lines in those theatres which possess a hand-worked flying system (for counter-weight systems, see below). Since often two men, and sometimes more, are required to tail-on to a set of lines working a hung piece, it is necessary to give some elbow-room here. On the other hand, the danger arises on a small stage of bringing the fly-floors out so far from the side walls as to come near the line of the side of the proscenium opening—thus enforcing uncomfortably narrow scenery, for, just as a scene must exceed the proscenium opening in height, so it must exceed it in width, by a matter of 2 ft. or more either side, in order to mask comfortably. This may reduce the possible width of a fly-floor to only 4 ft.—a modest allowance for men to work, haul in lines, pass each other, and in which to permit the occasional siting of side spots or flood lanterns, to say nothing of a thunder effect now and then.

The height of the fly-floors is important; to allow for the movement of flats underneath the floors to and from their packing positions, it must be a clear 1 ft. higher than the highest normal scenery used on the stage concerned.

Access to the fly-floors is preferably by stairs and corridors outside the stage area, and should be available independently from either side the stage. A bridge crossing behind the proscenium arch should connect the floors to allow of escape should either stair become blocked. Vertical ladders from the stage are not recommended, since they interfere with packing space below, and frequently become impossible to descend in the event of a fire on the stage. If access by stairs outside the stage is possible only on one side, then the gallery on the other side should be used only for fitting, and not

ESSENTIALS OF STAGE-PLANNING

during performances for the working of a show—this for the sake of the safety of the fly-men.

The connecting bridge between the fly-floors should, if it is placed near the front of the stage, have provision made for hanging certain fly-lines *through* it—that is to say, it should have a floor in the form of a grating, or at

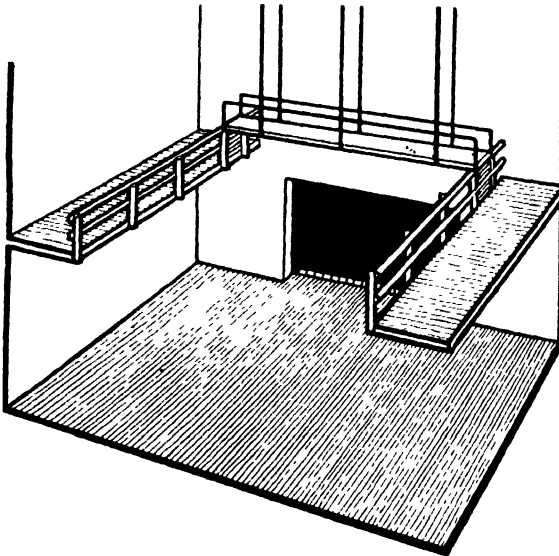

Fig. 55. The Cross-stage Bridge, communicating between the Fly-floors.

least containing apertures. This is not, of course, because it is possible to fly any piece of scenery through the bridge, but because it is generally in precisely this position that the items of the No. 1 lighting batten come. This may be a plain compartment batten, or a spot- and flood-bar, or both together. Such items seldom need to be flown high, but they may need to be lowered to the stage for adjustment, and so they are hung on lines under the bridge. The floor of the connecting bridge should therefore admit of lines of this sort passing through

it. Moreover, the bridge must not directly adjoin the back of the proscenium wall, but leave an interval of at least 1 ft. 6 ins. for the working of the safety curtain, the first Proscenium border, the tabs, and possibly an act drop. The bridge should be no wider than is absolutely necessary.

When a stage is equipped with a single-purchase, counterweighted flying-system, the fly-floor may not be essential, but a *loading gallery* will be needed instead just under the grid. The loading gallery (see Figs. 40 and 58) is simply a gangway suspended so as to give access to the counterweight cradles at their upper limit of travel. It should, of course, be capable of taking considerable weight, since from it the weights are loaded on, or removed from, the cradles to balance the weight of the various pieces of scenery flown.

In a double-purchase counterweight system the working-gallery or fly-floor is needed as well as the loading gallery.

CHAPTER EIGHT

ANCILLARY STAGE OFFICES

TO make particular recommendations to architects for the disposition of the ancillary offices around a stage is not easy, for much variation is possible both in their size and in their placing. Every individual case is, of course, so entirely dependent upon the shape of site for the building that it is as well that some variation is possible. And yet, in spite of this initial freedom, the final relation and detail of the parts can make for efficiency, or cause endless inconvenience.

There is only one room that must be situated immediately adjacent to the stage and at stage level—the property-room, being as it is the only stage office which is continually in use during the performance. Its minimum dimensions may be set at 12 ft. square. It must contain its own gas or electric point, running water and sink, and ample shelf space.

The need for a spacious carpenter's workshop is not to-day the same in all theatres. In London especially, most scenic construction is done by outside contractors, and the finished set is delivered at the door in pieces which only need assembly and occasional adjustment. But in all theatres there should be both a small carpenter's room and an electrician's store-room, situated near the stage but not necessarily on stage level. The carpenter's room is a small workshop for running repairs, with space for a full-sized bench; with water and gas or electric points laid on, with tool cupboards and a small desk. It should be made to lock up. The electrician's room requires a bench in addition to store space. He too requires power points.

When, on the other hand, a theatre builds its own productions, it requires a large carpenter's workshop as well as the carpenter's room. But it is important to emphasize that this must always be adjacent to (a) the store, and (b) the paint-room. The ideal is for all three to be incorporated in the theatre building provided that the workshop can be so situated that noise cannot penetrate to the stage during rehearsals. But if, for reasons of space, any one of these three departments cannot be included in the theatre

ESSENTIALS OF STAGE-PLANNING

building, then the whole trio should be relegated to another site, for their functions are interdependent.

The design of a paint-room is essentially a matter for a technician, and the dimensions of the store should make every allowance for the accumulations of years.

A carpenter's workshop should be at least high enough to handle the tallest flats normally used in the theatre, and spacious enough to erect a complete set without removing the work benches.

Provision must be made for the storage of costumes, if possible in the theatre itself. In any case a workroom and fitting-room must be included in the theatre where costumes can be tried on in spare moments during rehearsal, and where they can be looked after during the run of a play.

The number and disposition of dressing-rooms depend on the character and size of the theatre. Their planning demands as specialized a knowledge of the actor's needs as the planning of a paint-room depends on the painter's. It is a matter for a technical consultant, and the most knowledgeable consultant on this subject is the theatrical dresser.

FINAL CONSIDERATIONS

CHAPTER NINE

SOME GENERAL CONSIDERATIONS ON THE FRONT-OF-HOUSE

THE authors do not consider it part of their province here to discuss the front-of-the-house in anything like the detail of the foregoing chapters on the stage. This is not because the problems of designing an auditorium or of arranging a satisfactory foyer or box-office vestibule are any less considerable than those of designing a stage, but because front-of-house matters are, firstly, more obvious affairs than the concealed world behind the curtain, and, secondly, because it is only in certain aspects that they demand specialized theatre knowledge. In so far as concerns the disposition of the seats in regard to sight-lines, a complete method for studying and testing any scheme has already been offered in *Proscenium and Sight-lines*. In regard to acoustics, the trained architect is probably in a better position to handle this controversial subject than people of the theatre, for it principally concerns building, not speaking. Reference is recommended to the technical section of the *Handlist of Books on Theatres* compiled by the library-staff of the Royal Institute of British Architects, where, beside acoustics, works on ventilation and illumination are mentioned. And, finally, in so far as concerns the arrangement of the front-of-house offices, the opinion of the business manager is of greater final importance than the opinion of the players or stage-technicians.

In spite of all this, there remain certain considerations which may be usefully made here.

(a) *The Auditorium*

Concerning the architect's approach to the design of the auditorium, it would appear from observation of theatres to-day that he may perhaps be tempted to conceive his scheme too exclusively from the viewpoint of a spectator facing the stage, and when the house-lights are on. It is very

ESSENTIALS OF STAGE-PLANNING

important, however, that the whole should also be considered from an actors' position upon the stage, looking on to the audience—and with the house-lights out.

The success of an auditorium from the theatrical point of view largely depends on the effect it makes upon an actor at work, and here arises the chief problem of auditorium design—to arrange it in such a way that the contact between the actor and the audience is as close and as easy and as delicate as possible. We have touched this matter in earlier pages but it is worth while to reiterate that an auditorium may possess many of the more obvious advantages of comfort, airiness, ease of access and so forth, yet fail to achieve that less obvious quality which brings it the reputation, among actors, of being a good house to play in. This quality has been little studied, for it is the actor alone who can test it, and though the actor or the producer may recognize at once just which house does, and which does not, possess this quality, yet he may find the reason very difficult to define. The following observations may however be made:

It must be understood by the architect that an actor *uses* a theatre; a theatre that is difficult to handle, or use, encumbers his work. Any individual who has lectured in various places must realize how easy it is to speak in some halls and how difficult in others. Much the same considerations obtain in theatres.

With reservations, it is true that the actor wants to be as close as possible to the audience, and that the audience, on the other hand, need to be as close as possible to each other. The channel, or sense, by which the recognition of contact with an audience is conveyed to an actor is not easy to define. It is generally held, for instance, that it is not by direct sight, and that mostly the actor does not like to *see* his audience. It seems likely that the sense of hearing plays a big part and that much is conveyed in the rustlings or silences of the audience. 'You could hear a pin drop' is a proverbial expression for enthralled attention. But whatever the sense, it is an indirect one and something which can operate in the actor while he is still employing all his obvious faculties upon the management of his job.

It is held to be difficult to establish this sensation of 'contact' satisfactorily if the audience is not a unity. Thus in a well-designed auditorium the parts of the house should not be widely separated or arranged so that a sense of isolation from each other arises. In this connection it is interesting to notice what happened at a certain semi-private Ensa performance at Drury Lane during the war. A bomb had penetrated roof and upper circle,

CONSIDERATIONS ON THE FRONT-OF-HOUSE

leaving comparatively small holes, to explode in the grand circle. Temporary repairs were possible to the upper circle, but the circle below could not be used. In these circumstances, the performance was given to an audience occupying the stalls and upper circle only, leaving the grand circle empty. The result so far as the performers were concerned was a notable impression of a split audience, offering considerable difficulties to play to and creating a sense of having to appeal in two different directions and handle two independent and unsynchronized fields of response at one and the same time. So strongly was this difficulty felt that such entertainments were thereafter given in the other Ensa theatre, the Fortune, till the repair of Drury Lane circle became possible after the war.

Thus it follows that when designing an auditorium a nice adjustment is necessary between the fault on the one hand of too low a circle—so oppressive to those who sit immediately beneath it—and, on the other hand, of a circle designed with little regard to the other spectators, so that no sense of intercommunication is left.

A notable tendency in modern auditorium design has been towards the elimination of circles altogether and the disposition of the audience upon a single sloping floor or amphitheatre. In one sense, this design assists the unity of the audience. On the other hand, it goes against the other principle of closeness to the stage. The inclusion of at least a shallow circle at the back does enable a greater number of people to be situated nearer the stage.

It will appear from this that a single-tiered auditorium ought in general to be only a small one. At any rate, for presentations of intimate types of shows. The case of the great Greek single-tier theatres should not be applied here, since the type of performance upon those stages was in every way different from anything to be seen to-day.

To bring some practical recommendation into the matter of the dimensions of a single-tier auditorium, it might be pointed out that only rarely, in normal circumstances, are satisfactory seats found farther away than fifteen rows from the stage. It is possible perhaps, with skilful design, to construct a medium auditorium effectively to contain as many as twenty rows, but that figure is near the limit to which effective communication can extend.

The problem of the congenial auditorium is not one of depth alone. It may well be that a large auditorium can be built provided the contact of the nearer parts with the stage is very secure and direct. It is not unlikely that this intangible sense of contact possesses a quality somewhat in the nature of *flow*, and that if once a good beginning is made of communication with

ESSENTIALS OF STAGE-PLANNING

nearer spectators, then that sense is itself communicated, and those in front help to strengthen the contact of those behind, provided there is nowhere too great a barrier.

It is by such a path that we are brought to the consideration of the stage box. In itself the theatre box is outmoded and socially inconsistent. This last link with Georgian auditorium design is to-day generally abandoned. It is now found, however, that many actors miss the boxes; that something has gone which assisted their communication with the audience, brought the spectators towards the stage and formed a channel of contact across the barrier of the footlights and the gulf of the orchestra. Even when the boxes are unoccupied it has been claimed that their effect in this particular still operates.

A brief word on the theatre box is offered for consideration. The boxes were formerly held to be the best seats in the theatre; so much so that no Georgian playhouse failed to contain, not merely one either side the stage, but a complete row running down the sides of the house and round the end. These boxes crowded close upon the pit, so near that the pitees could whisper to the box-holders. Thus a sense of unity was maintained. Whatever may be said in its disparagement, the box must be allowed one quality: it *did* bring the audience very near the players—so close indeed as to allow actual physical contact on occasion. It is highly unlikely that these prized box-seats were celebrated for nothing. In the forestage-type of theatre, they *were* the best seats for seeing the actors, though not necessarily the scenery. In losing them it would be a pity if we also lost what they stood for, and made no attempt to restore the link between player and spectator that they undeniably afforded. Let it be thoroughly understood that we recommend no senseless reversion to boxes in circumstances where both the nature of the show and the nature of playgoing have altered. We do, however, stress the need for the theatre-designer to discover in his modern auditorium no less a capacity for facilitating that contact between player and spectator than his predecessors achieved. The problem still awaits solution.

Three final points may be added. A wide gulf between stage and first stalls often resulting from the building of too high a stage is bad. So, and for the same reason, is any form of 'tunnel' effect in an auditorium, resulting as it must do in a feeling in the actor that it is 'difficult to get down' to his audience. Lastly, any blank space of wall at either side of the stage-front and capable of producing a conscious or unconscious feeling of the audience's being removed because of its blankness is to be deprecated. Such a space is

CONSIDERATIONS ON THE FRONT-OF-HOUSE

very likely to arise when, either side the proscenium opening, there extend two, great, splayed surfaces, as high as the proscenium opening and leading off diagonally to join the walls of the auditorium at some relatively remote point. (This space is where the old stage boxes would once have been.) The arrangement is seen even in small theatres and huts where an attempt has been made to occupy what appeared waste space as triangular store-rooms either side, extending the wings towards the auditorium. The result is always an effect of isolation for the actor and a feeling of remoteness from the spectators. Moreover, such walls, when light in colour, do not assist in *concentrating* upon the stage picture by converging upon it; they rather tend to *diffuse* attention by reflecting a dim light beside it.

Any attempt at architectural *convergence* upon a stage must be very carefully controlled—especially when the stage is already set behind a proscenium arch—lest its effect should, like a view through reversed opera-glasses, make not for concentration but for remoteness.

A golden rule which should always be remembered is that though the auditorium of a theatre is a spectators' amenity, it must also be an actors' instrument. An audience uses an auditorium for its enjoyment; an actor uses it for his creation. A house may serve one purpose well, but fail in the other; but a good theatre must serve both.

In this connection, the colour of the auditorium is a matter of importance. Plain areas of white or light tone tend to distract attention from the stage; the modern desire for lightness and dislike for dark colours are not applicable in the theatre, where a quiet middle tone best sets off the scene.

(b) *Front-of-house Offices*

The public entrance to a professional theatre is used for more than one purpose. Prior to a performance it is the access for the audience but between (and sometimes during) performances it must also offer facilities for advance booking of seats, and, since tickets for the day's performance may also be sold at the door, it is of importance to design some sort of vestibule capable of serving all these functions without confusion and with as little waste of time and duplication of staff as may be. Generally two separate booking windows are needed: one for the day's seats and one for advance booking. Space for queueing should be arranged. Cloak-room and lavatory accommodation should be available in or near the vestibule and available on an adequate scale. Social conditions of theatre-going vary, but the vestibule often

ESSENTIALS OF STAGE-PLANNING

needs to be large enough to allow of conversation and of waiting for friends.

The custom of intervals during stage performances brings the need for a space for a promenade and foyer. If the site and the scale of the project allow that this foyer should be additional to the vestibule, it may well be useful to design a foyer sufficient in size to serve as a rehearsal-room during the daytime.

With the growth of the community centre idea, it may be that an immediately adjacent cafeteria or restaurant may be provided and entered by special communicating doors. It may be used for the purpose of a foyer or for bars as well as for before-the-show and after-the-show meals. Such an arrangement helps to remove the distracting sounds of conversation and crockery from the range of the auditorium.

In the matter of the 'interval', it may not be irrelevant to notice that a case is sometimes made out for the abandonment of such a social interruption in the progress of a play, and it is argued that a play should run through unbroken like a film, thus making a foyer unnecessary. Against this it may be pointed out that experiments with no-interval performances suggest that an average audience grows tired of concentrating on a play much sooner than on a film. There are psychological reasons for this which are outside the scope of this book, but it may be taken for granted that a theatre performance, as things go to-day, is something which involves a mounting and relaxing of attention; and that, before the final climax, at least one occasion should be provided for escape from the absorption which the close following of a play entails. Since, then, the best method of securing this relaxation is by means of an interval during which the audience may rise from its seats and stretch its legs, a good foyer must prove an important part of any working theatre.

(c) Stage Lighting

The lighting of the modern stage may be stated simply as a more or less elaborate disposition of six lights. Five of these are indicated in briefest simplicity at *A*, *B*, *C*, *D* and *F* on the sectional diagram in Fig. 60, and the sixth (*E*) (not easily representable on a cross-section) consists in the provision for some sort of side lighting across the stage either from stage-level, or diagonally downwards from the fly-floor above.

The disposition of such lights as are placed behind the proscenium-curtain do not materially affect the architect's plan of the stage, but there is

PICTORIAL GLOSSARY

ESSENTIALS OF STAGE-PLANNING

ALPHABETICAL LIST OF TERMS ILLUSTRATED IN FIGS. 57, 58 AND 59 (opposite) AND IN FIG. 15 (opposite p. 23)

(With references to certain relevant text figures)

- Act Drop, 1. See Fig. 15
Acting-area. See Fig. 19 (1)
- Back-cloth, 2.
Backing, door, 3 (Fig. 15)
Backing, fireplace, 4 (Fig. 15)
Backstage space, 5. See also Fig. 19 (3)
Batten, lighting, 'No. 1.' See Fig. 60 (A).
Batten lighting, sky, 8
Battens stiffening a wall of flats, 6 (Fig. 15)
Border, 9
Brace, extending, 10 (Fig. 15)
Brace, french, 41 (Fig. 15)
Brace rack, 11
Brace weight, 12 (Fig. 15)
Brake for counterweight lines, 70
Bridge, 14. See also Fig. 55
Bridle, 13 (Fig. 15)
- Carpet cut, 88. See also Fig. 18
Ceiling, 15 (Figs. 15 and 58)
Centre line, 16
Chimney for safety curtain counterweight, 17
Cleat, 18 (Fig. 15)
Compartment batten, 87 (Fig. 15)
Counterweight guard, 19
Counterweight lines, 20
Counterweight systems. See Figs. 40 and 41
Cradle, 21
Cradle guides, 22
Cue board, 23. See also Fig. 54
Curtain. See Front Curtain
Curtain set. See Fig. 5
Cyclorama, 24. See also Figs. 42, 43, 44 and 46
- Dip, 25 (Figs. 15 and 58)
Door backing, 3 (Fig. 15)
- Entrance door, 27
- Fire appliances, 28
Fire Curtain, 29
Fire flood, 30 (Fig. 15)
Fireplace backing, 4 (Fig. 15)
Fit-up. See Figs. 4 and 5
Flat, 32 (Fig. 15)
Flies. See Figs. 12 and 33 to 38
Flood, 33 (Fig. 15)
Flood, wing, 35
Fly bar, 36
Fly-floor or fly-gallery, 37
Foliage border, 38 (Fig. 15)
Footlights, 39
Forestage. See Figs. 22 to 28
French brace, 41 (Fig. 15)
French flat, 42. See also 6 in Fig. 15
French window, 43 (Fig. 15)
Front Curtain, 44
Furniture pack, 89
- Grid, 45
Groundrow, 46 (Fig. 15)
Grummet, 47 (Fig. 15)
- Hand lines, 48
Hanging iron, 40 (Fig. 15)
Head block, 50
- Lantern, 51
Lead, 52 (Fig. 15)
Lead-off steps, 53 (Fig. 15)
Length, 54 (Fig. 15)
Line (throw-), 55 (Fig. 15)
Lines (grid), 56
Loading floor, 57 also Figs. 40 and 41
Long line, 58. See also Figs. 33 to 38
- Monkey-stick. See Fig. 44
- O.P side, 59
- Pack, furniture, 89
Pack (scenery), 60 (Figs. 15, 20, 58 and 59)
Panatrophe, 61
Perch spots, 62
Prompter, 63 (also in Fig. 15)
Prompt side (P.S.), 64
Property table, 65 (Fig. 15)
Proscenium border, 86
Proscenium wings, 66.
- Return, 67 (Fig. 15)
Rostrum, 68 (Fig. 15)
- Safety brake for counterweight lines, 70
Safety curtain, 29
Sandbag, 71 (Fig. 15)
Scenery pack, 60
Short line, 72
Sill iron, 73 (Fig. 15)
Snaphook, 74 (Fig. 15)
Snatchline, 75 (Fig. 15)
Spot and flood bar, 77
Spot on stand, 78 (Fig. 15)
Stage cloth, 79 (Fig. 15)
Stage manager's desk, 80 (Fig. 15)
Stage screw, 81 (Fig. 15)
Switchboard, 82
- Tabs. See front curtain.
Thunder sheet, 83 (Fig. 15)
Tripe, 84 (Fig. 15)
- Wind machine, 85 (Fig. 15)
Wing space. See Fig. 19 (2)
Wing floods, 35
- Proscenium border, 86
Compartment batten, 87 (Fig. 15)
Carpet cut, 88
Furniture pack, 89

THE STAGE TODAY IN A TRADITIONAL THEATRE. THEATRES ARE BEING BUILT, AND WILL BE BUILT, IN MANY DIFFERENT STYLES. IN THESE FOUR PAGES WILL BE FOUND ASSEMBLED ALL THOSE MATERIAL ESSENTIALS WHICH WILL BE REQUIRED WHATEVER THE STYLE OF BUILDING.



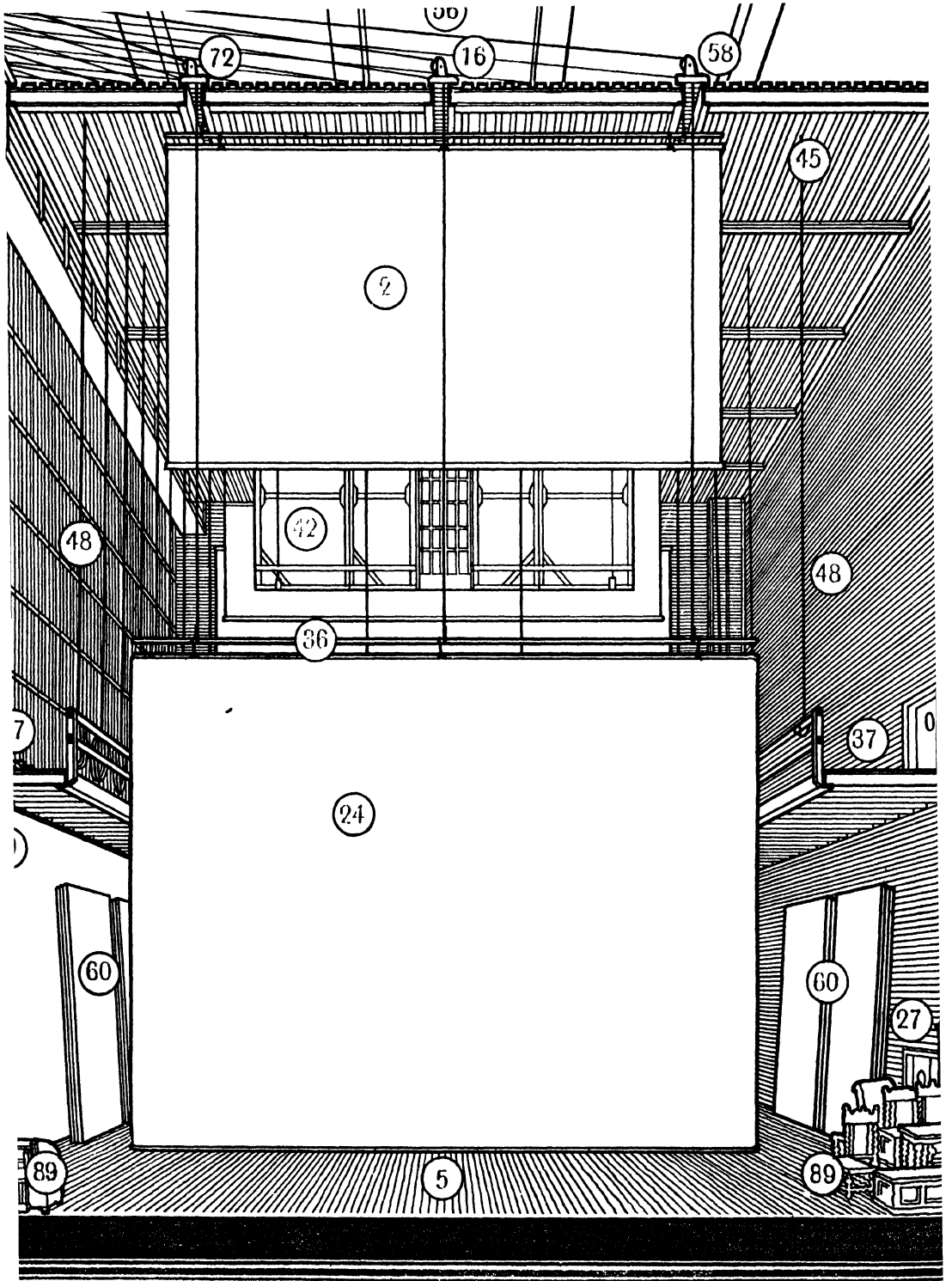

Fig. 59. The view from the rear of the Stage looking towards the Audience.

CONSIDERATIONS ON THE FRONT-OF-HOUSE

in this region one other matter which merits his close attention, and that is the proper provision for the switchboard.

A stage-lighting switchboard may be a comparatively large object, and it is advantageous if it can be worked by a man who can obtain some reasonable view of what is happening on the stage, and who must have some free

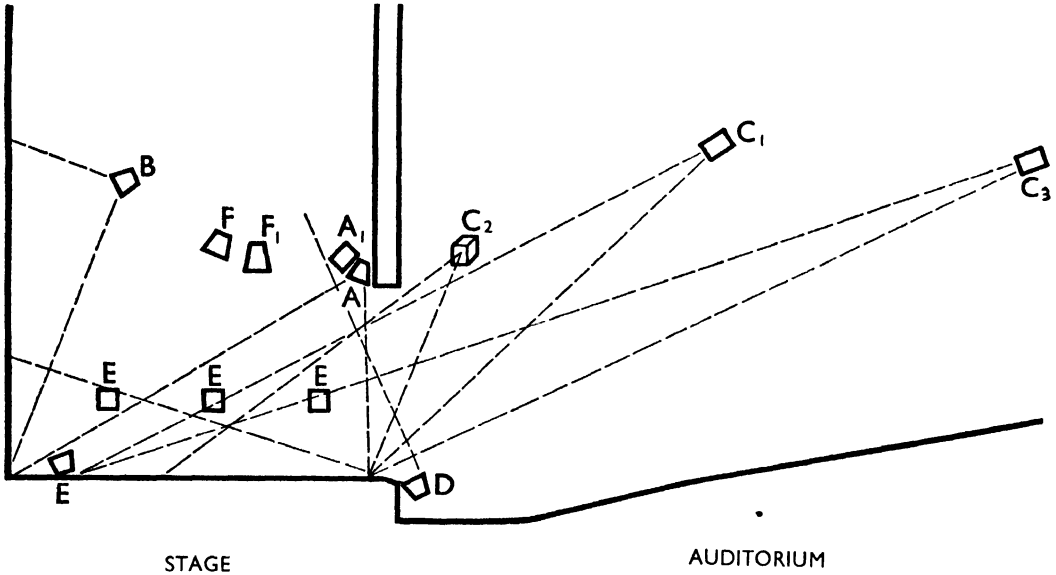

Fig. 60. The Six Basic Lightpoints are A, B, C, D, E, F.

- A—Lights actors and acting area from a point as far as possible downstage. Either open or, more satisfactorily, compartment type.
- A₁—Flood bar, spot bar, or spot-and-flood bar. If flood bar then batten at A may be omitted. All lanterns at A₁ may be tilted so as not to light the ceiling.
- B—Lights back scenery only. Floods or Batten.
- C₁—Centrally in hall, to light actors, or sections of stage, with emphasis. Should not fall on back scene.
- C₂—Side of auditorium. Provides cross-front lighting to pick out details in relief.
- C₃—Back of auditorium. Central. To reinforce light on actors. Needs careful use to avoid shadows on back. All C must be spots.
- D—To balance top effect of A on actors down-stage. To reinforce slightly and generally. To illuminate upper back of box-sets.
- E—Stage side lighting. Standard floods, 'boomerangs' or spots. Such points should be distributed up and down stage, and ideally both at stage and fly-floor level.
- F—Possible auxiliary compartment battens (depending on depth of stage) between borders.
- F₁—Acting Area Lanterns, possible addition or alternative to F. Should not directly light scenery.

space in which to move. Consultation should take place between the designers of the theatre and a reputable and experienced firm of theatrical electricians¹ at a very early stage in the development of the project. The size of board necessary to control whatever system of lighting is agreed upon must be fixed, and it must be realized that those dimensions will not only include the flat area of the board (often a considerable enough item in

¹ For instance, the Strand Electric and Engineering Co. Ltd.

ESSENTIALS OF STAGE-PLANNING

itself), but the depth of space needed, not only by the actual board, its switches in front and its machinery behind, but also in front of the board for operation, and *behind* the board for free and safe access on occasion to the connections and machinery at the back for maintenance purposes. It is quite possible for the cubic area thus required to average, in a normal theatre, 8 ft. long by 8 ft. high by 7 ft. deep. All this space should be provided ideally without encroaching on the wing-space *at any level*.

Systems of dimmer-placing under the stage (with operation from a remote point, in some cases in the front-of-house) have been used in order to save room on the stage, and at the same time to provide the operator with an unrestricted view of the stage.

Consideration should always be given to the very real problem rising from the noise of switch-operation. On small stages remote (contactor) switches are desirable for master and blackout switches of any size. Distracting noises are, of course, absent with the remote type of dimmer control.

The electrical capacity and design of the board must be a matter for expert consultation, but the designer of a theatre should have a very clear idea of his maximum future requirements and the absolute necessity for flexibility in the original layout before going into consultation. Though it is the duty of the contracting firm to supply an efficient plant judged from a purely practical standpoint, scales of artistic tastes vary, and no such firm can be certain of satisfying—or should be expected to satisfy—the artistic views of the designer unless the designer has those views clearly laid down before he consults the firm, or agrees upon the establishment of them with the firm before technical considerations are gone into.

Much valuable assistance for shaping these artistic views to suit the needs of the theatre under design may be found in the following works: Harold Ridge, *Stage Lighting* (Heffer, 1930); Ridge and Aldred, *Stage Lighting* with bibliography; (Pitman; reprinted, 1945); Theodore Fuchs, *Stage Lighting* (1929); Selden and Sellman, *Stage Scenery and Lighting* (Harrap, 1930). Concerning lighting, now, which is placed in front of the proscenium-curtain, certain points may be made which do materially affect the architect's plan.

Footlights. A decision must be made for or against the inclusion of footlights. Though much may be said against footlights in specialist circles, there is no doubt that the day of the footlights in general procedure is not yet over. They provide a valuable source of balancing and qualifying light. Their over-use, or too-great strength, are serious errors but on the whole

CONSIDERATIONS ON THE FRONT-OF-HOUSE

there is little doubt that, in general use, footlights will be needed, though means should be provided for temporarily removing them, or covering them over, in the event of their presence being an obstruction on the stage floor—as, for instance, at the addition of a temporary forestage. Possibly the circumstances wherein footlights are least likely to be needed are on very small stages, principally using curtain-sets, and in small theatres using full scenery but also equipped with stage- and front-of-house lighting near enough, and of such power, that reflections upwards from the (possibly partly-polished) floor of the stage approximates to the degree of reflection-upwards, in the normal world, of light from the sky (and that is a pretty considerable item of general daylight—for loss of which, in the theatre, footlights help to make up).

Front-of-house Lighting. It is, however, in the understanding provision for sources of front-of-house lighting that the designer of a theatre can offer the most valuable help. Lighting from the 'front of house' may be divided into three categories which are here discussed in order of importance.

At some point distant enough from the proscenium to prevent their too vertical rays falling unbecomingly on players down-stage, a row of spot-lights is nearly always found valuable to-day. In a small theatre this row of spots may be accommodated behind a return breaking the line of the ceiling, or it may be suspended on a bar and masked with some sort of metal decoration or other type of concealment—or, in a simple hall, may be left bare. The higher these lights have to be, the farther they need setting from the proscenium. The direction of the beam should be very roughly around 45 degrees from the vertical.

It is essential that each such spot-lantern (and this applies to every front-of-house light) should be immediately accessible for adjustment—if possible during the performance, but certainly when the auditorium is empty. The useful number of separate lamps at this position varies from about four upwards.

The next important positions for sources of front-of-house lights are either side the stage, lighting the actors' sideways, and slightly from the front, and slightly from above. Such lamps may be either in the side wall of a small auditorium, or even close to the stage in a panel between the proscenium and the nearest boxes, in which position they give excellent service at the well-designed Arts Theatre, Cambridge. Two lanterns are valuable at either side position.

ESSENTIALS OF STAGE-PLANNING

The final possible source of front-of-house lighting is at some distance from the stage, directly in front of the actor and a little above him. Frequently a battery of spots is built into the front of the first circle, but if their beams are liable to cast actors' shadows on the back-cloth, they may have to be situated higher. Such lamps should of course be so accommodated as not to interfere with the sight-lines of the audience both above and below the lanterns.

There are definite limits beyond which high-efficiency projector-lamps cannot be tilted without materially shortening their life and the location of all front-of-house spotlights should, therefore, be discussed with the specialist contracting firm in the very early stages of the project.

Any front-of-house light should be from a spot-lantern and not a flood-lantern, so as not to spill, and light up the auditorium or front of the proscenium.

BIBLIOGRAPHY

TO the subject of stage- (and theatre-) planning, the Royal Institute of British Architects has given careful attention. The Library of that Institute has provided a handlist of those of its books and periodicals that touch the subject. This list has not only the merit of being very full in itself, but refers to books and articles every one of which can be consulted at one place in London.

It seems, then, that no better bibliography on the subject of this book could be offered than the handlist, and by the very kind permission of the Librarian of the Royal Institute of British Architects we include it here, making a very small addition of certain books not yet included in the list.

REFERENCES TO BOOKS, ARTICLES AND ILLUSTRATIONS COMPILED FROM MATERIAL IN THE LIBRARY OF THE ROYAL INSTITUTE OF BRITISH ARCHITECTS

- A. Books, articles and special numbers.
- B. Technical.
- C. Stage Design.
- D. Examples: arranged alphabetically by countries and towns.

A. BOOKS, GENERAL ARTICLES AND SPECIAL NUMBERS

*Indicates that the book is in the Loan Library.

Architectural Design and Construction, 1939, March, p. 99.

Architectural Forum (N.Y.), 1932, September.

Architectural Record (N.Y.), 1938, July, p. 96.

Architecture d'Aujourd'hui, 1933, No. 7.

Arkitekten (Copenhagen), 1937, Nos. 1-2.

ESSENTIALS OF STAGE-PLANNING

Nuevas Formas (Madrid), 1936, No. 7.

Scottish Architect, 1939, June.

Werk (Zürich), 1936, November.

AIKMAN, A. E. *Design and Construction in the Repertory Theatre*. R.I.B.A. Final Exam. Thesis, 1934.

American Architect and Architecture (N.Y.), Data Supplement, 1937, July, p. 87.

Architectural Record (N.Y.), 'Community Theatres,' 1939, October, p. 77.

— 'Theatres and Auditoriums, U.S.A., 1891-1941,' 1941, February.

— 'Recreation Buildings (including Theatres),' 1941, April, p. 77.

— 'Cultural Centres (including Theatres),' 1941, September, pp. 75-94.

Byggmästaren (Stockholm), Article on 'Small Theatre Planning,' 1942, No. 7, pp. 86-94.

COLE, E., and BURRIS-MEYER, H. 'The Performance in the Theatre,' *Pencil Points* (N.Y.), 1945, June, pp. 80-5.

HOME OFFICE *Manual of Safety Requirements in Theatres and other Places of Public Entertainment*, 1934, London, H.M.S.O., 1939.

JELlicoe, G. A. *Shakespeare Memorial Theatre*, London, Benn, 1933.

KORNFELD, IA. 'Central Theatre of the Red Army,' *Architektura S.S.S.R.*, 1940, August, No. 8, p. 27.

LONDON COUNTY COUNCIL. (*Entertainment Buildings*) *Places of Public Entertainment—Protection from Fire . . . with respect to . . . the Protection from Fire of Premises . . . for the Public Performance, et cetera. The Metropolis Management and Building Acts Amendment Act, et cetera.* (No. 3398). Pamphlet. London, P.S. King, 1939.

— (*Entertainment Buildings*) *Places of Public Entertainment. Rules . . . 1940 . . . with regard to the Management* (No. 3455). Pamphlet. London, P.S. King, 1940.

LOWE, W. L. *The Modern Theatre*. R.I.B.A. Final Exam. Thesis, 1934.

McFAYDEN, J. S. *Design and Construction of Modern Theatres and Cinemas*. R.I.B.A. Final Exam. Thesis, 1935.

*MELOY, A. S. *Theatres and Picture Houses*. New York, 1916.

BIBLIOGRAPHY

- MOREAU, C., ed. *Theatres, Cinemas*. Paris, 1930.
- * MORETTI, B. *Teatri*. Hoepli, Milan, 1936.
- MOSHAMER, L. 'Thingstätt und ihre Bedeutung (Open-Air Theatres),' *Monatshefte für Baukunst*, 1935, December, p. 425.
- MOSS, GEOFFREY. *The Design and Equipment of Repertory Theatres*. R.I.B.A. Final Exam. Thesis, 1937.
- NICOLL, A. *Development of the Theatre*. London, 1927.
- PAWLEY, F. A. 'Sight-lines in Theatres.' *Pencil Points*, 1942, April, p. 177.
- * PICHEL, I. *Modern Theatres*. New York, 1925.
- POULAIN, R. *Salles de Spectacles et d'Auditions*. Paris, Freal et Cie, 1930.
- REINIUS, L. 'The Modern Theatre,' *Arkitekten*, 1942, No. 1, pp. 1-8.
- SEXTON, R. W., ed. *American Theatre of To-day*, Vol. 2. New York, 1930.
- * SHAND, P. M. *Modern Theatres and Cinemas*. Batsford, 1930.
- SOUTHERN, R. *Proscenium and Sight-lines*. London, Faber and Faber, 1939.
- Studio*. 'Soviet Art,' special number, including theatre design, 1944, February.
- Werk*. 'The Swiss National Theatre,' 1941, March, p. 65.
- * ZUCKER, P. *Theater und Lichtspielhauser*. Berlin, 1926.
- * ZUCKER and STINDT. *Lichtspielhauser und Tonfilmtheater*. Berlin, 1931.

B. TECHNICAL

- APPLEBEE, L. G. 'A Cavalcade of Stage Lighting,' *Illuminating Engineer*, 1935, March, p. 69.
- 'Theatre Lighting: Some Installation, Maintenance and Operating Problems,' *Electrical Supervisor*, 1945, February, pp. 93-8.
- Architectural Forum*. Articles on 'Acoustics,' 'Seating,' 'Lighting' and 'Air-conditioning,' 1932, September.
- Architektura S.S.S.R.* 'The Ventilation of the Red Army Theatre, Moscow,' 1941, No. 1, p. 58.
- BAGENAL, H. 'Theatre Acoustics: Some Results and Warnings,' *Journal R.I.B.A.*, 1939, Vol. XLVI, p. 500.

ESSENTIALS OF STAGE-PLANNING

- * BAGENAL and WOOD. *Planning for Good Acoustics*. Methuen, 1931.
- DAVIES, G. MORLEY. 'Atmosphere Research in Theatres and Cinemas. A survey in Bristol by the District Health Office,' *Heating and Ventilating Engineer*, 1942, September, pp. 82-5.
- KENWORTHY, G. N. 'Illumination of Theatres,' *Architecture* (N.S.W.), 1936, November; 1937, January.
- LONDON COUNTY COUNCIL. (*Entertainment Buildings*) *Places of Public Entertainment—Regulations and Rules with regard to . . . Structure and Lighting, Heating, Electrical, Ventilating and Mechanical Installations* (No. 3399). Pamphlet. London, P. S. King, 1939.
- RIDGE, H. *Stage Lighting*. Cambridge, 1935.
- * SABINE, P. E. *Acoustics and Architecture*. New York, 1932.

C. Stage Design

- BROLID, S. Articles on 'Stages,' *Byggmästaren*, 1942, No. 10.
- BURRIS-MEYER, H., and COLE, E. C. *Scenery for the Theatre, et cetera*. London, Harrap, 1939.
- CAMPOS, L. M. 'Stage Scenery Design and Architecture,' *Revista de Arquitectura* (Buenos Aires), 1944, November, pp. 489-500.
- HOLDING, EILEEN. 'Architecture in Stage Sets,' *Architectural Design and Construction*, 1937, January, p. 81.
- HURST, H. W. *The Stage: Its Construction for Specific Purposes*. R.I.B.A. Final Exam. Thesis, 1938.
- KRANICH, F. *Buehrentechnik*. 2 vols., Munich, 1929.
- MYERSCOUGH-WALKER, R. *Stage and Film Decor*. Pitman, 1940.
- SOUTHERN, R. 'The Scene-designer's Requirements in Planning Small Stages,' *Journal*, R.I.B.A., 1939, December 20th, p. 180.
- *Stage Setting for Amateurs and Professionals*. London, Faber and Faber, 1937.
- Werk*. 'Stage Design,' 1944, February, pp. 38-52.
- * ZINKEISEN, DORIS. *Designing for the Stage*. (*How to do it Series*, No. 18.) London, Studio Ltd., 1938.

BIBLIOGRAPHY

D. EXAMPLES

Great Britain

- BOURNEMOUTH. Little. Architects: Seal and Hardy. *Architect and Building News*, 1932, January 15th.
- BRIGHTON. Imperial. Architect: S. Beverley. *Builder*, 1940, April 19th, p. 471; *Building*, 1940, May, p. 100.
- CAMBRIDGE. A.D.C. Architects: Tomlinson and Dyson. *Architect and Building News*, 1935, January 25th.
- Arts. Architects: Kennedy and Nightingale. *Architect and Building News*, 1936, February 14th.
- Festival. Architect: E. Maufe. *Architect and Building News*, 1927, January 7th.
- LONDON. Duchess, Catherine Street. Architect: E. Barr. *Builder*, 1929, November 29th.
- Saville, Shaftesbury Avenue. Architects: T. P. Bennett & Son. *Building*, 1931, September.
- People's Palace, Mile End Road. Architects: Jones, Son and Smithers. *Builder*, 1936, December 18th.
- Whitehall. Architects: E. A. Stone. *Builder*, 1930, October 3rd.
- Gower Street. Architects: Swan and Norman. *Architects' Journal*, 1932, January 6th.
- Savoy, Strand. Architect: F. A. Tugwell. *Building*, 1929, November.

Abroad

Austria

- VIENNA. Architects: A. Popp and F. Zoymer. *Moderne Bauformen*. (Stuttgart), 1939, October, p. 497.

Czechoslovakia

- BRUNN. Architect: E. Hruska. *Forum* (Bratislava), 1937, No. 3, p. 50.

Denmark

- NEAR COPENHAGEN. Bellevue. Architect: A. Jacobson. *Architect and Building News*, 1938, June 10th, p. 299.

ESSENTIALS OF STAGE-PLANNING

Eire

ACHILL ISLAND. Open-air Theatre. Architect: N. Moffett. *Architects' Journal*, 1941, September 25th, p. 217; *Architectural Review*, 1941, August, p. 61.

France

PARIS. Trocadéro, New State Theatre. Architects: Carlu, Boileau and Azéma. *Architecture* (Paris), 1938, August 15th, p. 263; *Architects' Journal*, 1938, September 1st, p. 370.

— Pigalle. Architect: C. Siclis. *Building*, 1929, November, pp. 532-6.

Germany

ALTONA. Schiller. Architects: Esselman and Gerutke. *M. für Baukunst*, 1933, July, p. 297.

BAYREUTH. Festival. Architect: H. C. Reissinger. *Baugilde* (Berlin), 1938, August, p. 765.

BERLIN. Olympic Stadium Theatre. Architect: W. March. *Techniques et Architecture* (Paris), 1943, March-April.

COLOGNE. Apollo. Architect: E. Huhn. *Moderne Bauformen*, 1941, No. 2.

FRANKFURT-AM-MAIN. Schumann. Architect: R. Frankel. *M. für Baukunst*, 1933, July, p. 57.

MUNICH. National (reconstruction). Architect: R. Neithardt. *Baumeister* (Munich), 1936, May, p. 160.

ROSTOCK. Thingplatz. Architect: A. Abel. *Baugilde* (Berlin), 1935, No. 16.

Holland

ANTWERP. Schowburg. Architect: H. Martenbrock. *De 8 en Opbouw.*, 1936, November 14th.

UTRECHT. Architect: W. M. Dudok. *Architectural Review*, 1946, February, p. 57.

Hungary

BUDAPEST. (Project). Architect: P. Kaffra. *Ter es Forma*, 1935, No. 2.

Italy

MILAN. Olympia. Architect: E. Faludi. *Architectural Record* (N.Y.), 1935, p. 123.

MONTESACRO. Italian Lictorial Youth Organization Theatre. Architect: G. Minnucci. *Architettura* (Milan), 1939, December, p. 693.

BIBLIOGRAPHY

OLEGGIO. Architect: G. Franzì. *Architettura Italiana* (Turin), 1938, No. 1, p. 3.

ROME. l'Eliseo (renovated). Architect: L. Piccinato. *Edilizia Moderna* (Milan), 1938, October–December, p. 4; *Architettura* (Rome), 1939, March, p. 143.

Japan

TOKYO. Kokusai. Architect: I. Narimatu. *Kentiku Sekai* (Tokyo), 1937, September, p. 9.

Norway

OSLO. People's Theatre. Architect: Morgenstjerne and Eide. *Bygge Kunst*, 1935, April, pp. 63–70.

SARPSBORG. Folkets Hus. Architect: A. Pedersen. *Bygge Kunst*, 1934, Vol. 16, p. 113.

Sweden

GÖTEBORG. Stadsteater. Architect: C. G. Bergsten. *Byggmästaren Ark.*, 1934, pp. 191–6.

HALMSTAD. Architect: S. Brolid. *Byggmästaren*, 1942, No. 10.

KARLSKRONA. Architect: G. Jacobson. *Byggmästaren*, 1939, No. 14, p. 197.

LUND. Architects: Bockstrom and Reinins. *Byggmästaren*, 1942, No. 10.

MALMÖ. City. Architects: Lallerstedt, Lewerentz and Hellden. *Architect and Building News*, 1945, April 20th; *Architectural Forum*, 1945, February, pp. 129–38; *Architectural Review*, 1946, March, pp. 72–6; *Byggmästaren*, 1944, No. 22, p. 395; *Form* (Stockholm), 1944, Nos. 8–9, pp. 167–72; *Irish Builder and Engineer* (Dublin), 1945, February 10th; *Official Architect*, 1946, March, pp. 134–41.

MALMÖ. Toun. Architects: Lallerstedt and Lewerentz. *Byggmästaren*, 1942, No. 10, p. 130.

STOCKHOLM. Kungl. Dramatiska Teaterns (studio). Architect: E. Ahlsen. *Byggmästaren*, 1945, June 22nd, No. 13, pp. 229–37.

Turkey

ISTANBUL. Stadttheater. Architects: Hellmayer and Gangl. *Baumeister* (Munich), 1936, April, p. 172.

ESSENTIALS OF STAGE-PLANNING

U.S.S.R.

- KHARKOV. Architects: J. Curman and others. *Baugilde*, 1931, p. 1,562; *Byggmästaren*, 1931, p. 83.
- MOSCOW. Palace of Culture. Architect: Ia. A. Kornfel'd. *Architektura S.S.S.R.*, 1939, No. 5, p. 39.
- Red Army Theatre. Architects: Alabian and Simbirtseff. *La Construction Moderne* (Paris), 1937, March 7th, p. 378; *Stroitel'svo Moskvi*, 1937, No. 8, p. 16; *Architektura S.S.S.R.*, 1938, No. 5, p. 57.
- Stanislavsky (reconstructed). Architect: A. N. Federov. *Stroitel'svo Moskvi*, 1938, Nos. 23-4; *Architektura S.S.S.R.*, 1939, No. 3, p. 63.
- ROSTOV. Gorki. Architects: Schouko and Guelfreiskh. *Architektura S.S.S.R.*, 1936, Nos. 1 and 3; *La Construction Moderne*, 1937, March 7th, p. 378.

U.S.A.

- BROOKLYN. Jewel. Architect: B. Schlanger. *Architectural Record*, 1937, June, p. 66.
- CHICAGO. Swift. Architects: Schiewe and Donaldson. *Architectural Forum*, 1934, July, p. 27.
- HAVANA. Open-air Theatre. Architects: Batista and Maza. *Architectural Record*, 1937, June.
- HOLLYWOOD. Pilgrimage Playtheatre (open-air). Architect: W. L. Woollett. *American Architect*, 1932, August, p. 67.
- KANSAS CITY. Open-air Theatre. *Architectural Forum*, 1944, April, p. 141.
- MADISON. University of Wisconsin. Architects: Hars, Corbett and MacMurray. *Architectural Forum*, 1940, July, p. 49.
- MICHIGAN. Delft (remodelled). Architect: M. M. Hare. *Architectural Forum*, 1938, September, p. 201.
- Model. Architect: W. L. Pereira. *Architectural Forum*, 1938, October, p. 270.
- MILWAUKEE. Humbolt Park. Architects: Clas and Clas. *Architectural Record*, 1934, November, p. 343.
- NEW YORK. Radio-Keith-Orpheum Theatre. Architects: Reinhard, Hofmeister and others. *American Architect*, 1932, December, p. 41.

BIBLIOGRAPHY

- RED ROCKS, DENVER. Open-air Theatre. Architect: Burnhan Hoyt, *American City*, 1944, March, p. 52; *Architectural Forum*, 1945, May, pp. 98-102; *Architects' Journal*, 1945, September 6th, pp. 164, 173-4.
- ROCKEFELLER CENTRE. Radio City Music Hall and Roxy Theatre. Architects: Reinhard, Hofmeister and others. *Architectural Forum*, 1933, February, p. 153.
- ST. LOUIS. *Architectural Record*, 1934, November, p. 365.
- SIoux FALLS. Hollywood. Architect: H. Spitznagel. *Architectural Record*, 1940, January, p. 39.
- SIoux CITY. Music Pavilion. Architect: H. Kamphoefner. *Pencil Points*, 1935, April, p. 171.
- WILMINGTON. Drama League. Architects: Victorine and S. Homsey. *Architectural Forum*, 1940, September, p. 164.
- WOODSTOCK, N.Y. Woodstock Playhouse. Architect: A. E. Milliken. *Pencil Points*, 1942, April, pp. 235-6.

Users of this list are also referred to the 'Review of Periodicals,' which appears in every number of the R.I.B.A. *Library Bulletin* and to the Periodicals Subject Index in the Periodicals Room on the Fourth Floor of the R.I.B.A. These contain references to all the more important articles and illustrations published in nearly two hundred journals received by the library, and enable this list to be brought up-to-date.

The above list was compiled in November, 1946. The following additions can be made to it.

ELIZABETHAN PLAYHOUSE

- ADAMS, J. CRANFORD. *The Globe Playhouse*. Harvard, 1943.
- FORREST, G. TOPHAM. *The Site of the Globe Playhouse, Southwark*. London, 1924.
- HODGES, C. WALTER. 'The Globe Playhouse,' *Theatre Notebook*, Vol. 1, No. 8, 1947, July, pp. 108-13.

GEORGIAN PLAYHOUSE

- SAUNDERS, G. *A Treatise on Theatres*. London, 1790.
- SOUTHERN, R. *The Georgian Playhouse*. Pleiades, 1948.
- 'Concerning a Georgian Proscenium Ceiling,' *Theatre Notebook*, Vol. 3, No. 1.

ESSENTIALS OF STAGE-PLANNING

VICTORIAN THEATRE

- BUCKLE, J. G. *Theatre Construction and Maintenance*. The Stage Office, 1888.
- FREEMAN, J. R. *On the Safeguarding of Life in Theatres*. New York, 1906.
- SACHS, E. O. *Modern Opera Houses and Theatres*. 3 vols., London, 1896-9.
- SOUTHERN, R. *The Wooden Stage of English Tradition, Theatre Royal, Leicester*. Wood, August, 1948, pp. 225-9.
- 'Interesting Matter relating to the Theatre Royal, Ipswich,' *Architectural Review*, 1946, August, pp. 41-4.
- WYATT, B. *Observations on the Design for the Theatre Royal, Drury Lane*. London, 1812.

GENERAL

- Architectural Forum* (N.Y.), 'Johnny Victor Theater,' 1947, August, pp. 57-60.
- Architecture, Urbanisme, Habitation* (Brussels). 'Theatres', various auditoriums. Architect: R. Ajoux. 1947, May, p. 69.
- L'Architecture d'Aujourd'hui*, Special Number, No. 9. 1938, September.
- Arquitectura* (Mexico). 'A Theatre in Guatemala.' Architect: C. S. Fernandez. 1945, August, pp. 48-55.
- L'Architecture Française*, 'Proposed Theatre, Istanbul.' Architects: A. & G. Perret. 1941, January, pp. 11-15.
- Bouw* (Amsterdam), 'New Theatre at Rotterdam.' Architect: J. H. van den Broek. 1947, March 22nd, pp. 95-8.
- Bouwkundig Weekblad* (Amsterdam), "'Lutusca" Theatre, Rotterdam.' Architects: J. P. L. Hendriks, W. van der Sluijs and L. A. van der Bosch. 1947, June 3rd, pp. 147-52.
- Building*. 'Soviet Theatre,' article by Sir Charles Reilly on Soviet Theatre Exhibition in London. 1946, March, pp. 69-72.
- CARD, C. 'Theatres: Theatre Design' (technical article), *Journal of Royal Architectural Institute of Canada*. 1947, April, pp. 107-31.
- LECLERC, HÉLÈNE. *Les Origines italiennes de l'Architecture théâtrale moderne*. Paris, E. Droz, 1946.

BIBLIOGRAPHY

- Neue Bauwelt* (Berlin), 'New Theatre "Haus der Jugend" in Hamburg.'
Architect: W. Kallmorgen. 1948, June 28th, p. 407.
- L'Ossature Métallique* (Brussels), 'The Reconstruction of the Theatre of Louvain,' technical article by M. Lens. 1948, May, pp. 211-22.
- La Revue Théâtrale*. 'Lois Scéniques.' Historical Survey by André Barsacq.
Paris, April, 1947.
- Progressive Architecture*, Long Beach, Cal. Architect: H. Gibbs. 1948,
January, pp. 69-71.
- South African Architectural Record*, 'The Old Theatres of Johannesburg.'
historical article by C. A. Stoloff. 1947, May, pp. 130-9.
- SCHUBERTH, O. 'The Problems of Modern Theatres', *Baumeister* (Munich).
1940, May, pp. 104-16.
- SONREL, P. *Traité de Scénographie*. Paris, 1943.

In the library of the British Drama League (9 Fitzroy Square, London, W.1), will be found a limited but useful selection of books dealing with the subject. Expert assistance may also be obtained from the League on all questions of theatre design and equipment. .

